

oben[®]
SINCE 1923
tiled shower solutions

walfer[®]

Pre-form bases

Level entry | Solutions for Timber Floors
Centre Drain



Oben History

Since 1923 Oben's family founders have been passionate about creating the perfect bathroom a place where water and wonderful ideas flow together in endless expressions of innovation, indulgence and design.

For over 95 years this proud family-owned business has dedicated itself to being first with the future and second-to-none with everything else!

It's an attitude that has made it an undisputed market leader and earned it an envied international reputation as a modern day pioneer of bathroom and showering technology.

Oben's innovative shower products are built with the same solidity, durability and quality as their reputation so that you may enjoy the pleasure of their performance and beauty of their designs for many years to come.



Derek Englefield

Managing Director



Contents

J-Walk In Shower - Curved	6 - 7
Walk-In Shower - Flat	8 - 9
Rectangular Corner Showers	10 - 11
Square Corner Showers	12 - 13
Alcove Showers	14 - 15
Neo-Angle Showers	16 - 17
Shower Niches/Foot Rest	18 - 19
Slide Glass® Easy Clean Glass	20
Product Finishes	21
Rock-Stone® Base Features & Benefits	22 - 23
Rock-Stone® Base Installation	24 - 25
Shower Niche Technical	26
Oben PVC Drains Technical	27
Oben Installation Services	28 -29
Custom Base Order	30 - 31
Base & Enclosure Technical - Corner	32 - 33
Base & Enclosure Technical - Alcove	34 - 35
F.A.Q.s	36 - 37

New build or renovating

It's never
been easier
to create
a Level Entry Shower

with Oben wafer®



Oben makes it easy

Tiler



"Oben makes it easy for me to create an exquisite tile shower, every time"

Oben technology - everything a tiler could wish for

- **100% Waterproof** shower base system
- Pre-formed slopes **guarantee drainage**
- **Rock-Solid** - no chance of movement
- Compatible with **any** waterproofing system
- Easy and fast to tile - **no crowning**

"With Oben behind us, we say "yes" to every shower request"

Quality and Service you can rely on

Builder



- **Established brand** since 1923
- High quality products you can **trust & depend** on
- Design solutions for **every shape** of shower
- **On time deliveries** - each time - every time!
- Hassle-free factory **installation service**

Home owners

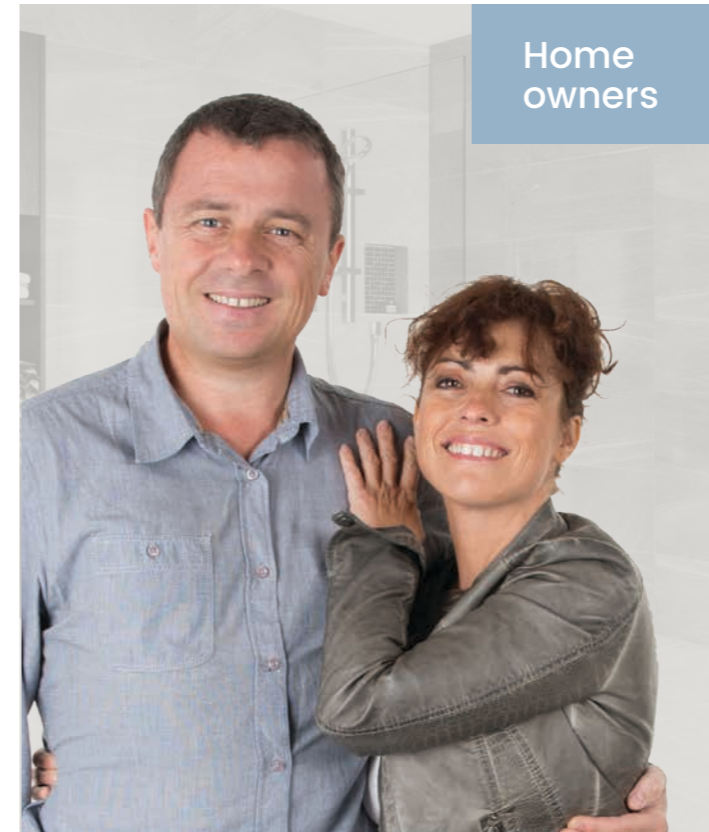

"The whole experience of designing one of the most important areas in our home has been a breeze with Oben"

- Oben brochures **makes it easy!**
- **"Peace of Mind"** - 25 year Leak Proof Guarantee
- Full range of tile showers - **Any Shape, Any Size**
- **Total package** - Drains, Base and Frameless Glass
- **Level Entry** design

"Oben, their precision in design and their history in the market says it all!"

Architect



- Oben brand - totally **dependable** and trustworthy
- Tiled shower solutions for **new** and **renovations**
- Oben offers the ultimate in **versatility** and luxury
- Sleek minimalist designs - **Function with style**
- Oben enables us to **design** any custom shower

Indulge



Curves create space
so Oben created
curves

With Oben you never know what's "round" the corner!
What you do know is that it's bound to be big on luxury like this
unique, Walk-In shower made from a single sheet of curved
toughened safety glass. The 'J' Walk-In Level Entry is a special
feature in any bathroom.

wafer® Base J-Walk Options

CORNER J-WALK

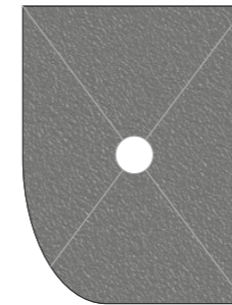

Left Hand Base

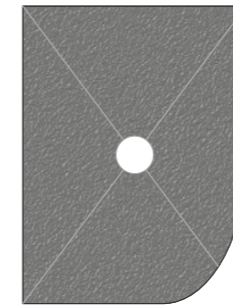

Right Hand Base

LENGTH X WIDTH
1250 X 900 - LH
1250 X 900 - RH

1250 X 1000 - LH
1250 X 1000 - RH

FEATURES - wafer® Base

- Level Entry Design
- Ultra Low 24mm Base
- Does NOT require rebating of joists in order to recess base
- 25 Year Leak Proof Guarantee*
- Left or Right Hand base options
- Polyurethane Adhesive rapid cure system included
- Drain options:
 1. "J" Gully Hi Flow Waste
 2. Easy Clean Waste

Base Hand must be specified at time of order

ENCLOSURE - FRAMELESS GLASS

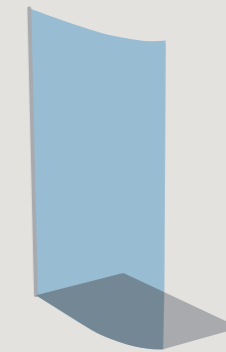

LH PANEL

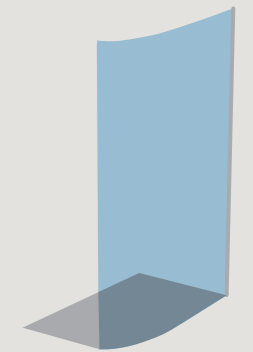

RH PANEL

FEATURES - Enclosure

- 8 mm Toughened Safety glass
- Curved LH & RH Glass Panels
- No stabilizing bar required
- Clear glazing
- Glass Height 1960 (Standard)
- 15mm adjustment for out of true walls
- Finishes Chrome, Brushed Stainless, Matt Black, White
- Glass Panel Length 1250



imagine



The ultimate
in versatility and
luxury

Step into luxury with the new range of Oben Walk-in free standing glass panels which do not require an overhead stabilising bar. The simplicity of a single sheet of toughened glass panel creates a luxurious Walk-In shower in any bathroom, the ease of walking into your shower with no doors to negotiate needs little explanation.

wafer® Base Walk-In Options

CORNER RECTANGLE

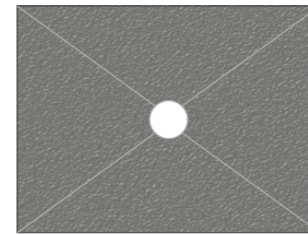

Centre Outlet

DEPTH X WIDTH
900 X 1200
900 X 1300
900 X 1400
900 X 1500
900 X 1600
900 X 1700
900 X 1800
900 X 1900
900 X 2000

1000 X 1200
1000 X 1300
1000 X 1400
1000 X 1500
1000 X 1600
1000 X 1700
1000 X 1800
1000 X 1900
1000 X 2000

FEATURES - wafer® Base

- Level Entry Design
- Does NOT require rebating of joists in order to recess base
- 25 Year Leak Proof Guarantee*
- Universal Base Design (No Left or Right Hand)
- Polyurethane Adhesive rapid cure system included
- Drain options:
 1. "J" Gully Hi Flow Waste
 2. Easy Clean Waste

ENCLOSURE - FRAMELESS GLASS

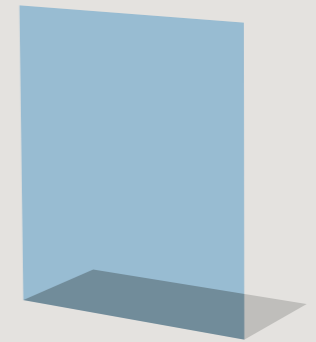

FIXED PANEL

FEATURES - Enclosure

- 10 mm Toughened Safety glass
- Reversible Left and Right Hand
- No stabilising bar required
- Clear glazing
- Glass Height 1960 (Standard)
- Custom glass height on request
- 15mm adjustment for out of true walls
- Finishes Chrome, Brushed Stainless, Matt Black, White
- Glass Panel Width (Standard)
900, 950, 1000, 1100, 1200

Luxuriate



Let yourself be inspired

The latest in minimalistic 10mm glass makes the slide shower an impressive design statement. Extra smooth stainless steel roller technology provides for smooth and effortless door opening and closing action. Minimalistic in appearance, this modern frameless sliding glass enclosure provides that truly "Frameless look" and is the flagship of the Oben shower range.

wafer® Base Rectangular Corner Options

CORNER RECTANGLE

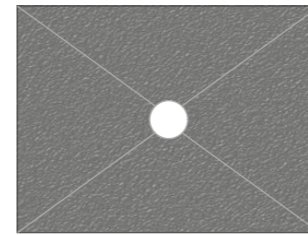

Centre Outlet

DEPTH X WIDTH
900 X 1200
900 X 1300
900 X 1400
900 X 1500
900 X 1600
900 X 1700
900 X 1800
900 X 1900
900 X 2000
1000 X 1200
1000 X 1300
1000 X 1400
1000 X 1500
1000 X 1600
1000 X 1700
1000 X 1800
1000 X 1900
1000 X 2000

FEATURES – wafer® Base

- Specifically designed for Timber floors
- Centre Drain Outlet Position
- Precise pre-fabricated slope
- Level Entry Design
- Joists Do NOT require rebating to recess base
- Cementitious Finish
- 100% Waterproof – 25 year Guarantee*
- Polyurethane Adhesive rapid cure system included
- Drain options:
 1. "J" Gully Hi Flow Waste
 2. Easy Clean Waste

ENCLOSURE – FRAMELESS GLASS

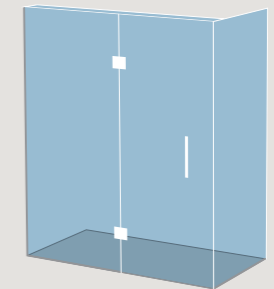

OFFSET DOOR
LH Hinge Shown

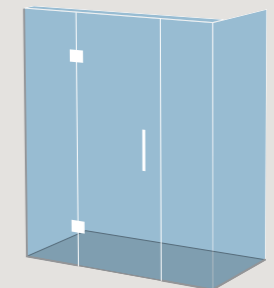

CENTRE DOOR
LH Hinge Shown

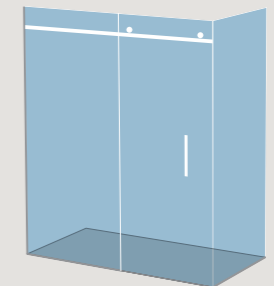

SLIDING DOOR
RH Door Shown

FEATURES – Enclosure

- 10 mm Toughened Safety glass
- Reversible Left and Right Hand Doors
- Clear glazing
- Glass Height:
 - Hinge Model – 1960 Glass Overpanel (Standard)
 - Sliding Model – 2050
- Custom glass height on request
- 15mm adjustment for out of true walls
- Finishes Chrome, Brushed Stainless, Matt Black, White

Revitalise



Adding new dimension to space

Oben's unique Square Corner features a glass return wall which gives the appearance of added space and light, bringing a whole new dimension to your bathroom. Manufactured from toughened safety glass with a single door available in left or right hand options.

wafer® Base Square Corner Options

CORNER CENTRE OUTLET

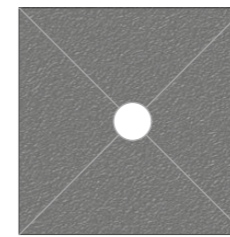

Centre Outlet

DEPTH X WIDTH

800 X 800

850 X 850

900 X 900

950 X 950

1000 X 1000

1050 X 1050

1100 X 1100

1150 X 1150

1200 X 1200

FEATURES - wafer® Base

- Specifically designed for Timber floors
- Centre Drain Outlet Position
- Precise pre-fabricated slope
- Level Entry Design
- Joists Do NOT require rebating to recess base
- Cementitious Finish
- 100% Waterproof - 25 year Guarantee*
- Polyurethane Adhesive rapid cure system included
- Drain options:
 1. "J" Gully Hi Flow Waste
 2. Easy Clean Waste

ENCLOSURE - FRAMELESS GLASS

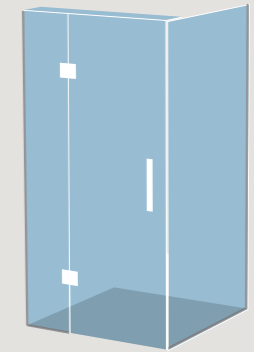

OFFSET DOOR
LH Hinge Shown

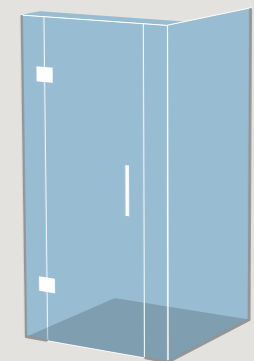

CENTRE DOOR
LH Hinge Shown

FEATURES - Enclosure

- 10 mm Toughened Safety glass
- Reversible Left and Right Hand Doors
- Frameless Glass Options Centre, Offset or Sliding Door
- Clear glazing
- Glass Height 1960 (Standard)
- Glass Overpanel (Standard)
- Custom glass height on request
- 15mm adjustment for out of true walls
- Finishes Chrome, Matt Black, Brushed Stainless, White.

Invigorate



Maximise your bathroom space

Oben's elegant Alcove recessed design not only gives you a great internal showering area, without taking up additional space, it also opens up new design possibilities. A sleek and luxurious recessed shower provides both function and style.

wafer® Base Alcove Options

ALCOVE RECTANGLE

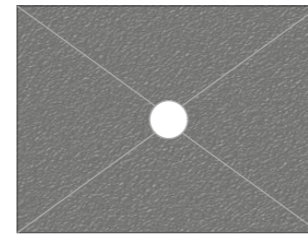

Centre Outlet

DEPTH X WIDTH
900 X 1200
900 X 1300
900 X 1400
900 X 1500
900 X 1600
900 X 1700
900 X 1800
900 X 1900
900 X 2000
1000 X 1200
1000 X 1300
1000 X 1400
1000 X 1500
1000 X 1600
1000 X 1700
1000 X 1800
1000 X 1900
1000 X 2000

ALCOVE SQUARE

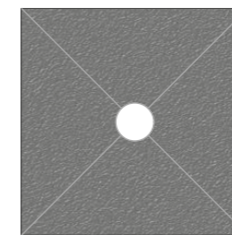

Centre Outlet

DEPTH X WIDTH
900 X 900
1000 X 1000

FEATURES - wafer® Base

- Specifically designed for Timber floors
- Precise pre-fabricated slope
- Level Entry Design (Maximum length 2000 mm)
- Joists Do NOT require rebating to recess base
- Cementitious Finish
- 100% Waterproof - 25 year Guarantee*
- Universal Base Design (No Left or Right Hand)
- Polyurethane Adhesive rapid cure system included
- Drain options:
 1. "J" Gully Hi Flow Waste
 2. Easy Clean Waste

ENCLOSURE - FRAMELESS GLASS

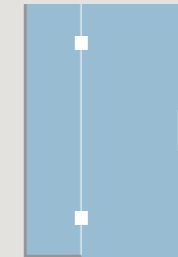

OFFSET DOOR
LH Hinge Shown

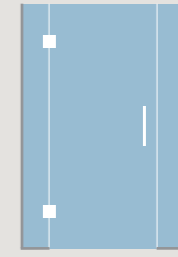

CENTRE DOOR
LH Hinge Shown

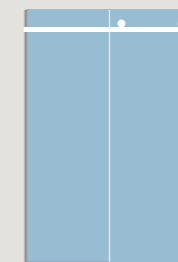

2P SLIDING DOOR
RH Door Shown

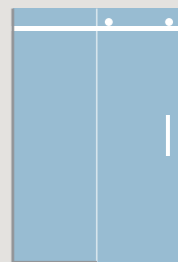

3P SLIDING DOOR
RH Door Shown



FIXED PANEL
LH Panel Shown

FEATURES - Enclosure

- 10 mm Toughened Safety glass
- Reversible Left and Right Hand Doors
- Frameless Glass Options
 - Centre, Offset or Sliding Door
- Glass Height:
 - Hinge Model - 1960
 - Sliding Model - 2050
- Custom glass height on request
- 15mm adjustment for out of true walls
- Finishes Chrome, Matt Black, Brushed Stainless, White

Enjoy



Where space is a luxury

Oben's practical, space saving Neo Angle corner shower not only maximises space, it also makes the most out of what you can do in a space devoted entirely to indulgence, relaxation and wellbeing. Neo Angle is made from 10mm toughened safety glass and comes with a single door in left or right hand options.

wafer® Base Neo-Angle Options

NEO-ANGLE CORNER

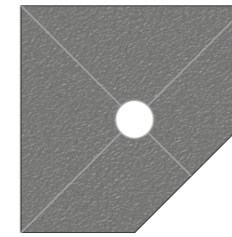

Centre Outlet

DEPTH X WIDTH
900 X 900
950 X 950
1000 X 1000

FEATURES - wafer® Base

- Specifically designed for Timber floors
- Centre Drain Outlet Position
- Precise pre-fabricated slope
- Level Entry Design
- Joists Do NOT require rebating to recess base
- Cementitious Finish
- 100% Waterproof - 25 year Guarantee*
- Universal Base Design (No Left or Right Hand)
- Polyurethane Adhesive rapid cure system included
- Drain options:
 1. "J" Gully Hi Flow Waste
 2. Easy Clean Waste

ENCLOSURE - FRAMELESS GLASS

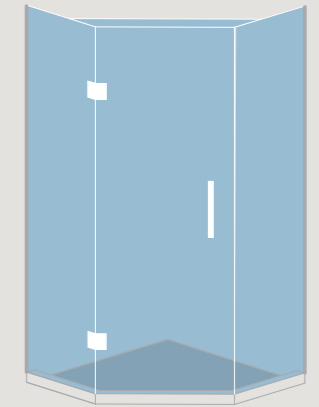

CENTER DOOR
LH Hinge Shown

FEATURES - Enclosure

- 10 mm Toughened Safety glass
- Reversible Left and Right Hand Doors
- Frameless Glass Centre Door
- Glass Height 1960 (Standard)
- Glass Overpanel (Standard)
- Custom glass height on request
- 15mm adjustment for out of true walls
- Finishes Chrome, Matt Black, Brushed Stainless, White

Shower niches

When remodelling a bathroom, consider adding a recessed shower niche into your design. It's a practical and streamlined way to add storage space for shampoos, soaps and accessories within your shower wall cavity, without taking away valuable elbow room.

Oben built-in recessed shower niches are a great alternative to chunky glass corner shelves and shower caddies. Available in a wide range of shapes and sizes to suit every installation.



MITRED EDGE



TILE TRIM



EXTERNAL EDGE FINISHES

A mitred tile edge will give your niche that professional stylish designer look. Ask your tiler to quote mitred edges, which is where the tiles are cut on a 45-degree angle so that the tile edges meet therefore eliminating the necessity for tile trims. Alternatively aluminium tile trim extrusions are available in a range of finishes.

FOOT REST

Oben's recessed Foot Rest offers a practical solution to shave your legs easily and safely in the shower.



NICHE 600 X 300

Adding a wall niche is a very practical and elegant way to create more storage space in your bathroom. Recessed wall niches enhance your bathroom design and provide a place to conveniently stow all your shampoos, shower gels and other shower items. Available in a range of sizes to match any bathroom style.

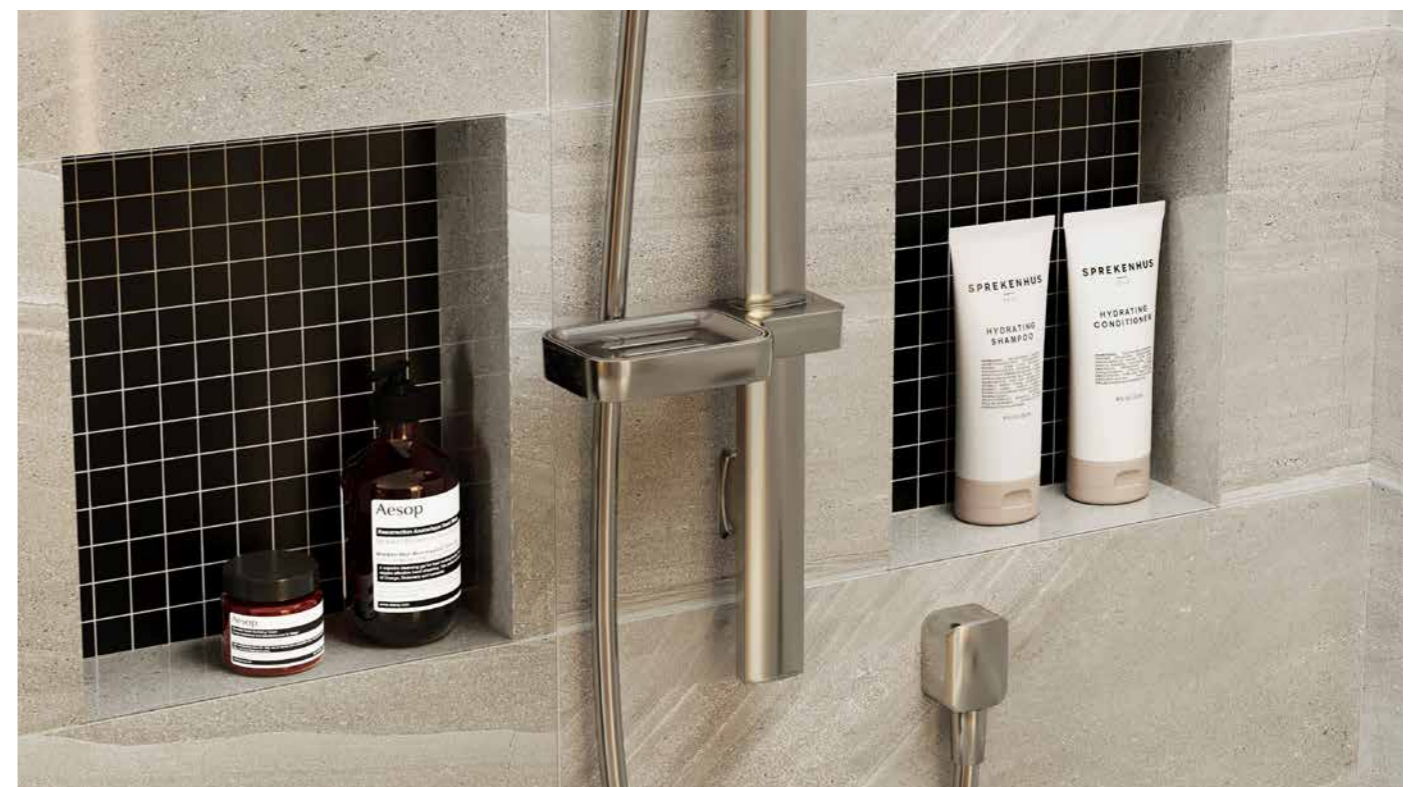

NICHE 300 X 300 His 'n' Hers®

Accessories as shown not included

What is Glide Glass®

THE NON-STICK EASY-CLEAN GLASS

Glide Glass® is proprietary protective nano coating developed by Oben.

A long lasting protective coating for glass showers, making glass easier to clean and maintain like new.

Glide Glass reduces cleaning time by repelling lime scale and soap residue deposits from adhering to the glass surface, which results in significantly reduced time and effort for cleaning.

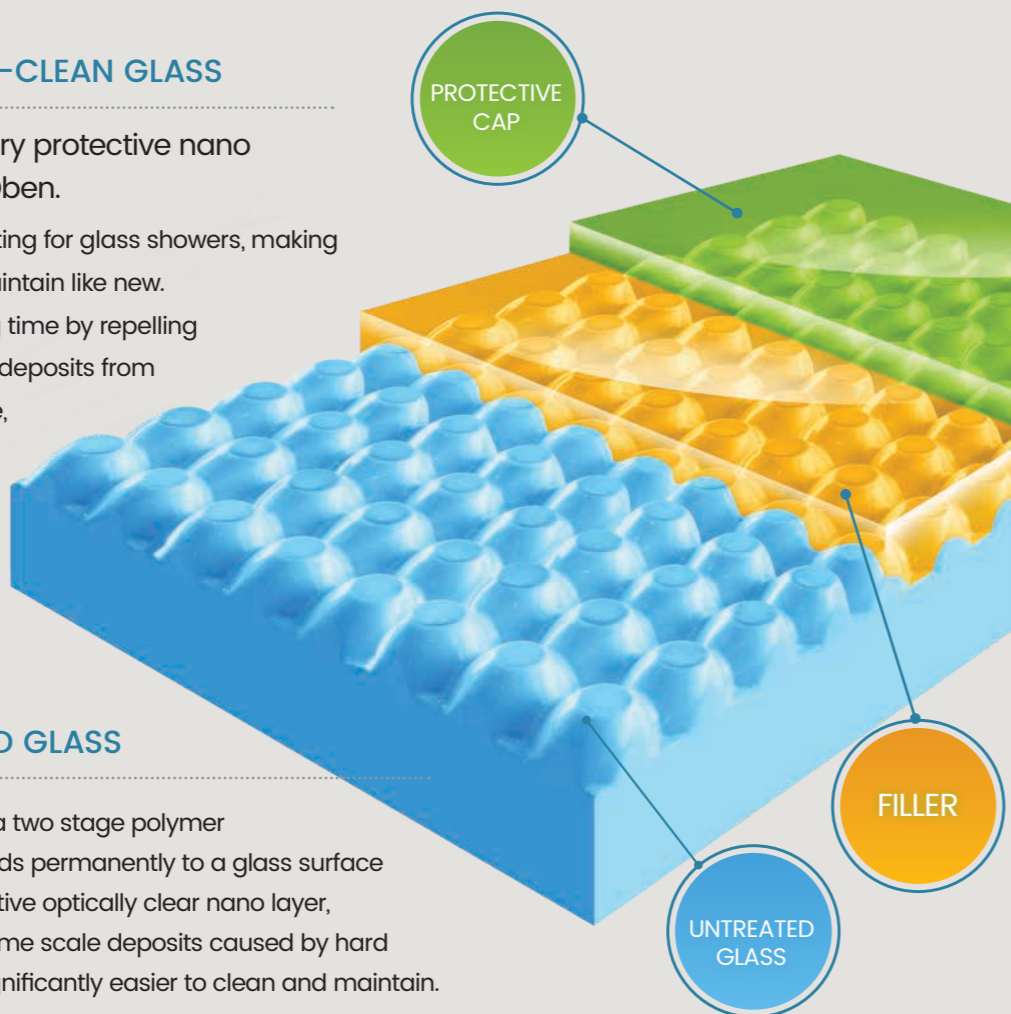

WHAT IS THE DIFFERENCE BETWEEN TREATED & UNTREATED GLASS

Glide Glass® treated glass is a two stage polymer chemical reaction which bonds permanently to a glass surface providing an ultra thin protective optically clear nano layer, resistant to soap scum and lime scale deposits caused by hard water, making the surface significantly easier to clean and maintain.

Makes glass easier to clean and maintain like new.

- Highly water repellent (Hydrophobic)
- Resistant to Hard water
- Less frequent cleaning
- Reduces mould & bacteria build up

UNTREATED GLASS

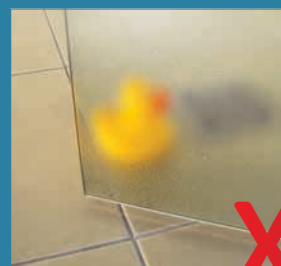

TREATED GLASS



Glide Glass®

Keeps your frameless glass shower looking like new!



NON-STICK, EASY-CLEAN GLASS

Glide Glass® - Optional Extra, only available for **NEW** glass installations and must be specified at time of frameless glass shower order.

Average price for **Glide Glass®** Nano application per shower approximately \$150 - \$350 depending on shower size, includes Consumer Care & Maintenance Kit.

Product Finishes

HANDLES

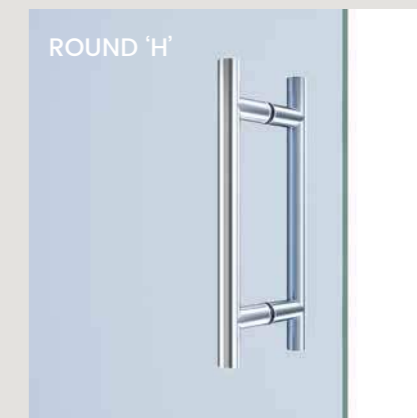

HINGES



FINISHES



CHROME
(Standard)



BRUSHED STAINLESS
(Non-Standard)

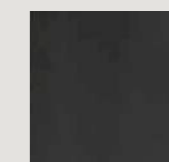

MATT BLACK
(Non-Standard)



WHITE
(Non-Standard)

Note: Surcharge applies to non-standard finishes

OBEN PRODUCT WARRANTY SCHEDULE

CATEGORY	NON COMMERCIAL USE	
Rock-Stone® Shower Bases	25 Year	
Rock-Stone® Niches	25 Year	
Rock-Stone® Hobs	25 Year	
Shower Drains	15 Year (Excludes powder-coated finishes*)	
Showers (Glass & Hardware)	5 Year	
Mirrors	1 Year (Excludes mirrors installed directly onto a vanity top)	
Shower Seals (Vinyl/PVC)	1 Year	

*Powder-coated Drains - Matt Black and White drain finishes available on request, but supplied **No Warranty**. Powder-coated finishes are not suitable for drain installations. Oben recommends Stainless Steel finishes only which is covered by Oben's 15 year warranty. Refer to www.oben.co.nz for further warranty Terms & Conditions.

1

100% WATERPROOF

The high density 50kg/m³ closed cell cross linked XPS core is 100 % waterproof.

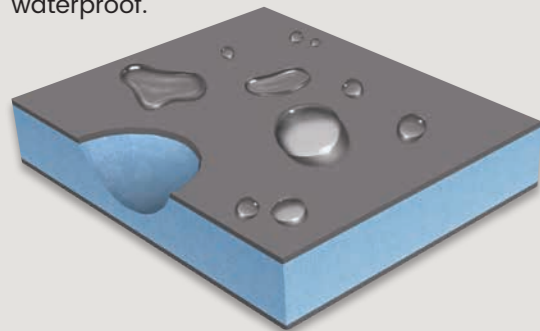

4

BASE ADHESIVE KIT INCLUDED

A fast setting waterproof Polyurethane adhesive designed for bonding Oben wafer® base direct to timber substrates.



2

ROCK-SOLID CONSTRUCTION

The **polyceramic**-coated surface forms an incredibly strong and stable base for ceramic tile adhesive.

- Polyceramic Layer
- Reinforcing mesh
- Cross-linked HD XPS Core
- Brick mesh
- Polymer Cement layer

3

Precise flat planes for easy tiling, no crowning.



5

LOW PROFILE DESIGN

Designed to fit within existing 20 mm timber floor substrate, no more rebating joists. Rebate depth of 26mm and overall base height of only 24mm.



6

25 YEAR WARRANTY*

The 25-year quality guarantee applies to the entire Rock-Stone® base range. Oben is setting new standards when it comes to quality leadership.

7

"KNOCK - KNOCK"

Feel the difference
The Rock-Solid feel of Oben Rock-Stone® base says it all.

8

PRECISELY PRE-FABRICATED SLOPE

The perfectly faceted slope ensures optimum tiling. Pre-Formed slope guarantees surface drainage.

9

PRODUCT RANGE

More options, more shapes! Sizes from 800 mm wide to 2000 mm long as well as Centre and Offset drain outlet positions.



100% Waterproof



Save up to 50% on installation time



Guaranteed slope angle to drain



Superior strength and impact resistance



Easily installed



Suitable for all tile sizes



Easily cut



Superior thermal insulating qualities



Superior sound insulating qualities



Dimensionally stable

wafer[®] Base Installation

Specifically designed

for timber floors.

Oben makes it Easy!

A revolution in Level Entry Base Design



1 Mark outline of base on timber floor.



2 Cut out 20mm flooring and remove.

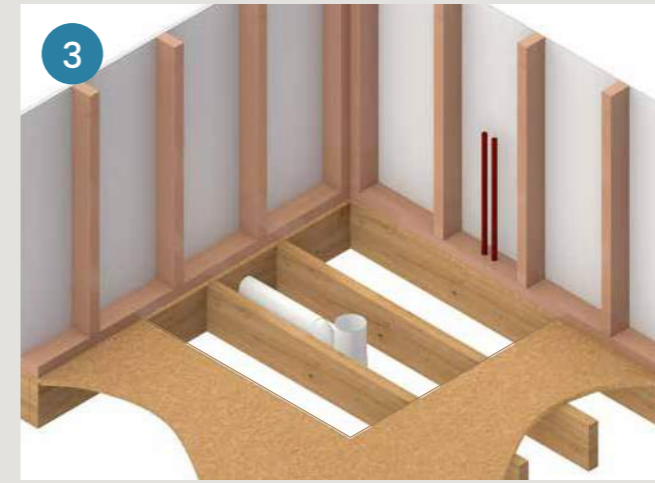

3 Install plumbing (drain riser, hot and cold water pipes).

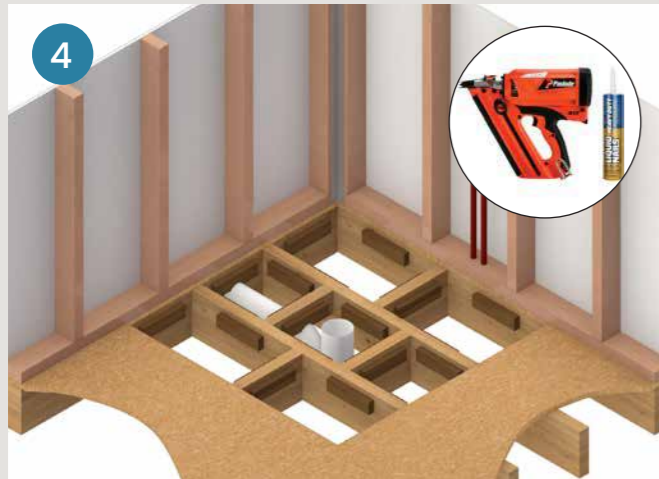

4 Fix nogs or extra joists where required, to provide support to all edges of the ply infill.



5 Infill between joists with marine ply or compressed sheet. Glue & screw into position.



6 Install Gib/Villa board walls ensuring it follows rebate in base profile.



7 Fix Tile & Slate to floor outside shower pan area. Apply Polyurethane adhesive - 2 hour cure time. (Adhesive Kit included)



8 Fit wafer[®] base and weight down with adhesive pail filled with water.

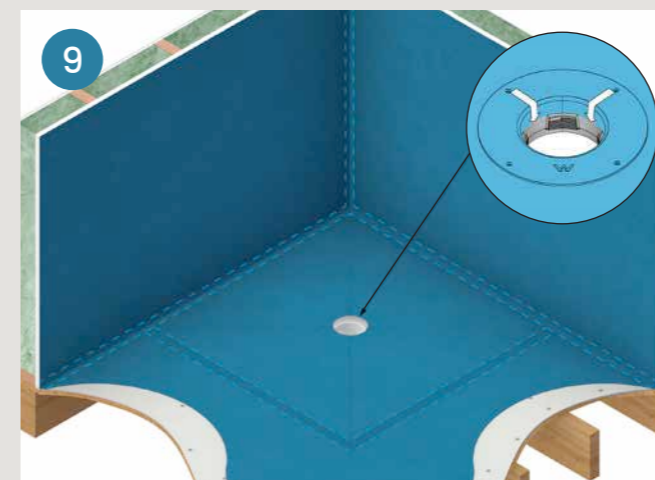

9 Apply butyl tapes and waterproof floor and walls. Excludes waterproofing - supplied by others.

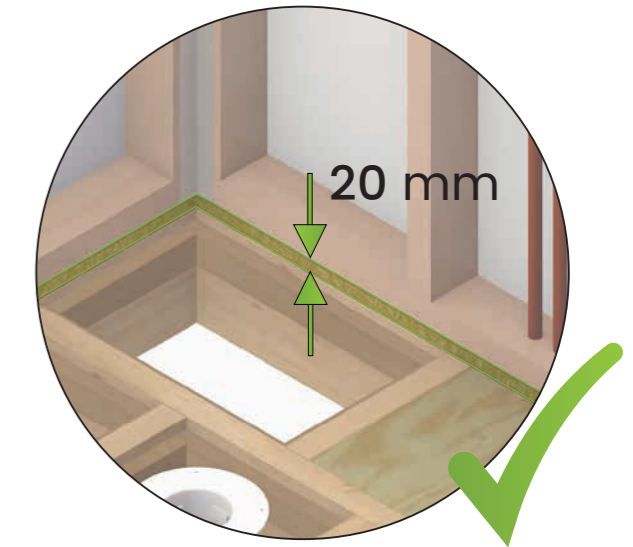

- Ultra Low 24mm Profile
- No Joist Rebate required
- Quick and Easy Installation
- Fast 2 hour Adhesive Cure



Traditional Level Entry Installation

- Expensive
- Additional Labour and Materials
- Requires Joists to be Rebated

Recessed Tile Niches - Rough in

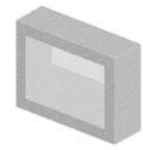

Foot rest

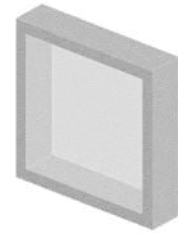

Square

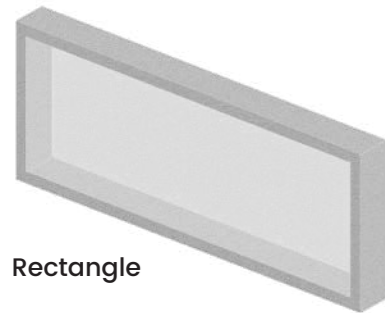

Rectangle

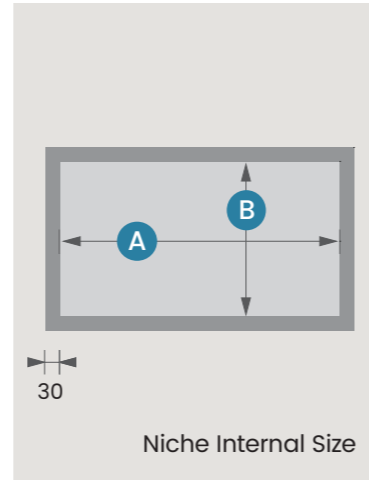
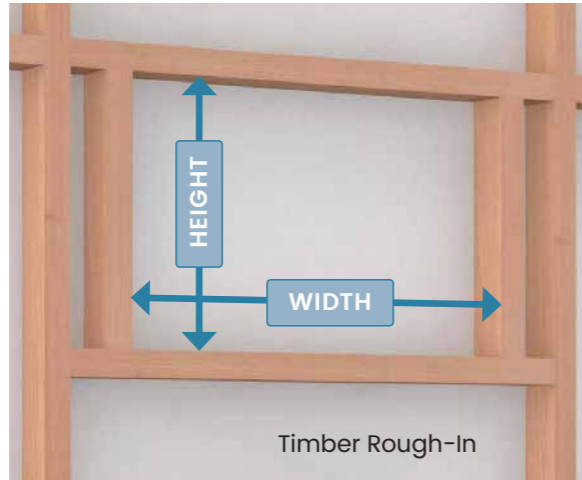

RECESSED NICHE 95MM STUD

Type	Model	Timber Rough-In			Niche Internal Size (excludes tiles)	
		Width	Height	Depth	A	B
Foot Rest		300	250	95	235	185
Square	300 X 300	400	400	95	335	335
Rectangle	600 X 300	700	400	95	635	335
Rectangle	800 X 300	900	400	95	835	335
Rectangle	900 X 300	1000	400	95	935	335
Rectangle	1000 X 300	1100	400	95	1035	335
Rectangle	1200 X 300	1300	400	95	1235	335
Rectangle	1500 X 300	1600	400	95	1535	335

*Also available in 75mm stud depth on request



1 Rough-In timber framing to support niche - Ref (Niche Rough-In Guide)



2 Fix Gib / Villa Board, dry fit niche, remove and apply adhesive.



3 Install niche, ensuring front face is flush with front face of Gib/Villa Board.

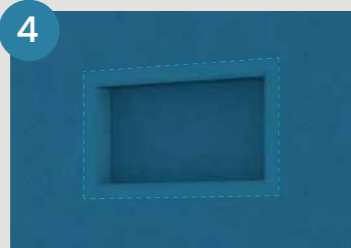

4 Apply Butyl Tapes and waterproof wall and niche.

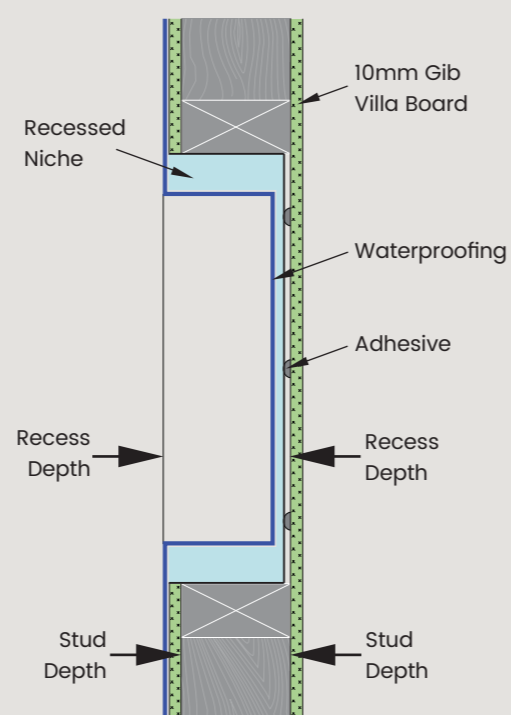

Oben Tile Drains



J GULLY HI FLOW TILE DRAIN
100 x 50

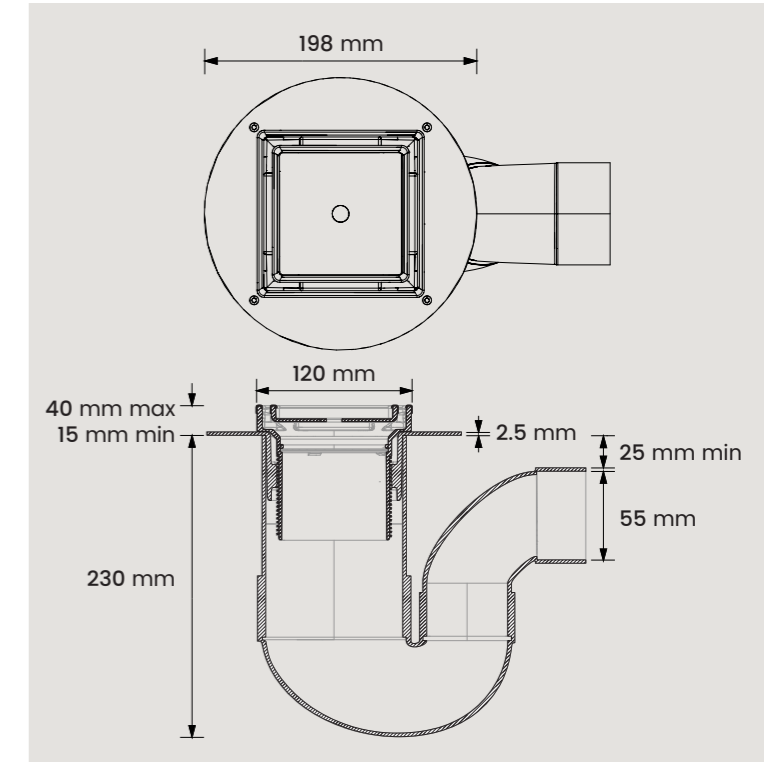

EASY CLEAN TILE DRAIN
100 x 50

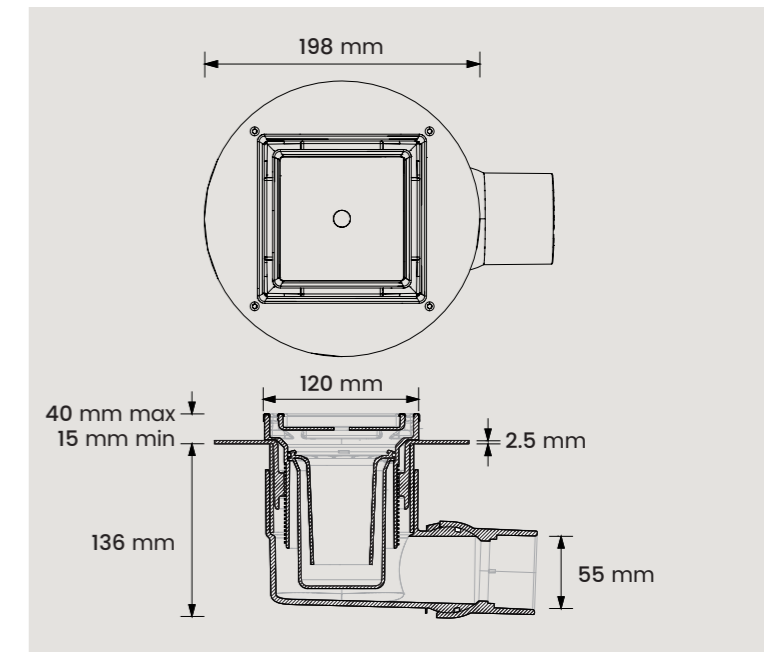

AN INVISIBLE DRAIN SOLUTION

Oben's NEW tile insert drain eliminates the need for a traditional grate in your shower.

The tile insert drain cover allows you to create a seamless and almost invisible finish, allowing your shower floor tile choice to become the drain cover.

A small perimeter slot allows water to drain making the drain virtually invisible.

Base installation easy as 1 2 3

Polyurethane adhesive kit



Floor Substrate

- ✓ Plywood
- ✓ Timber
- ✓ Tile & Slate underlay
- ✓ Composed fibre cement sheet
- ✗ Concrete floor

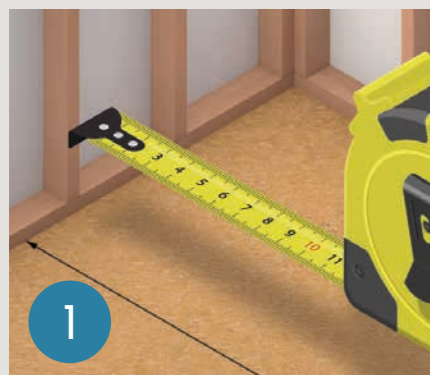

1 Measure / Dry fit base



2 Applying polyurethane adhesive

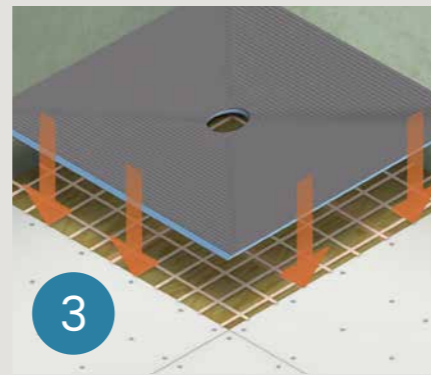

3 Installing base

A perfect fit every time

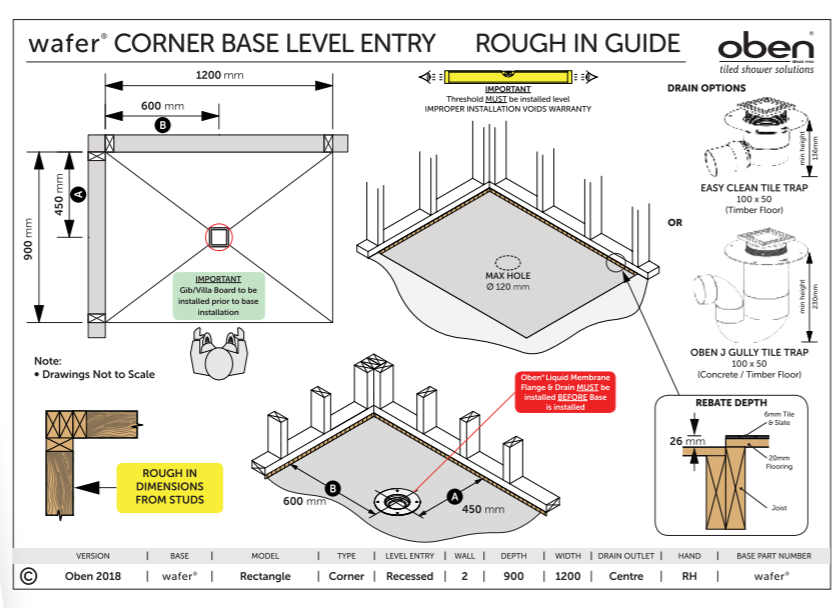
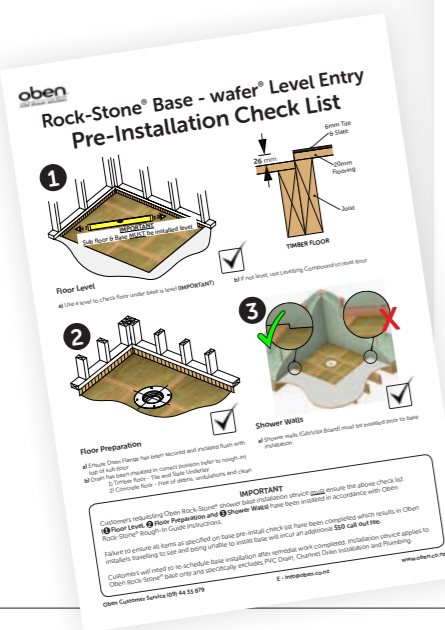

The best guarantee of all

For over 95 years Oben's founders have set their own benchmark of excellence through innovative design, quality products and a passion for service that continues long after purchase.

All Oben products are made from the highest-quality materials and assembled only by trained craftsmen. Superior design and function are matched by a level of robustness and durability that is, ultimately, **the best guarantee** of all.



Delivery Nationwide

- ✓ Rock-Stone® Base
- ✓ Rock-Stone® Niches
- ✓ PVC Shower Drains
- ✓ Channel Drains
- ✗ Excludes Frameless Glass showers (Auckland Region only)



CALL **oben**

T: 09 44 33 879

E: sales@oben.co.nz

www.oben.co.nz

Order custom size

Creating your custom size shower is easy with Oben

Any shape
Any size

Any Shape - Any Size Base

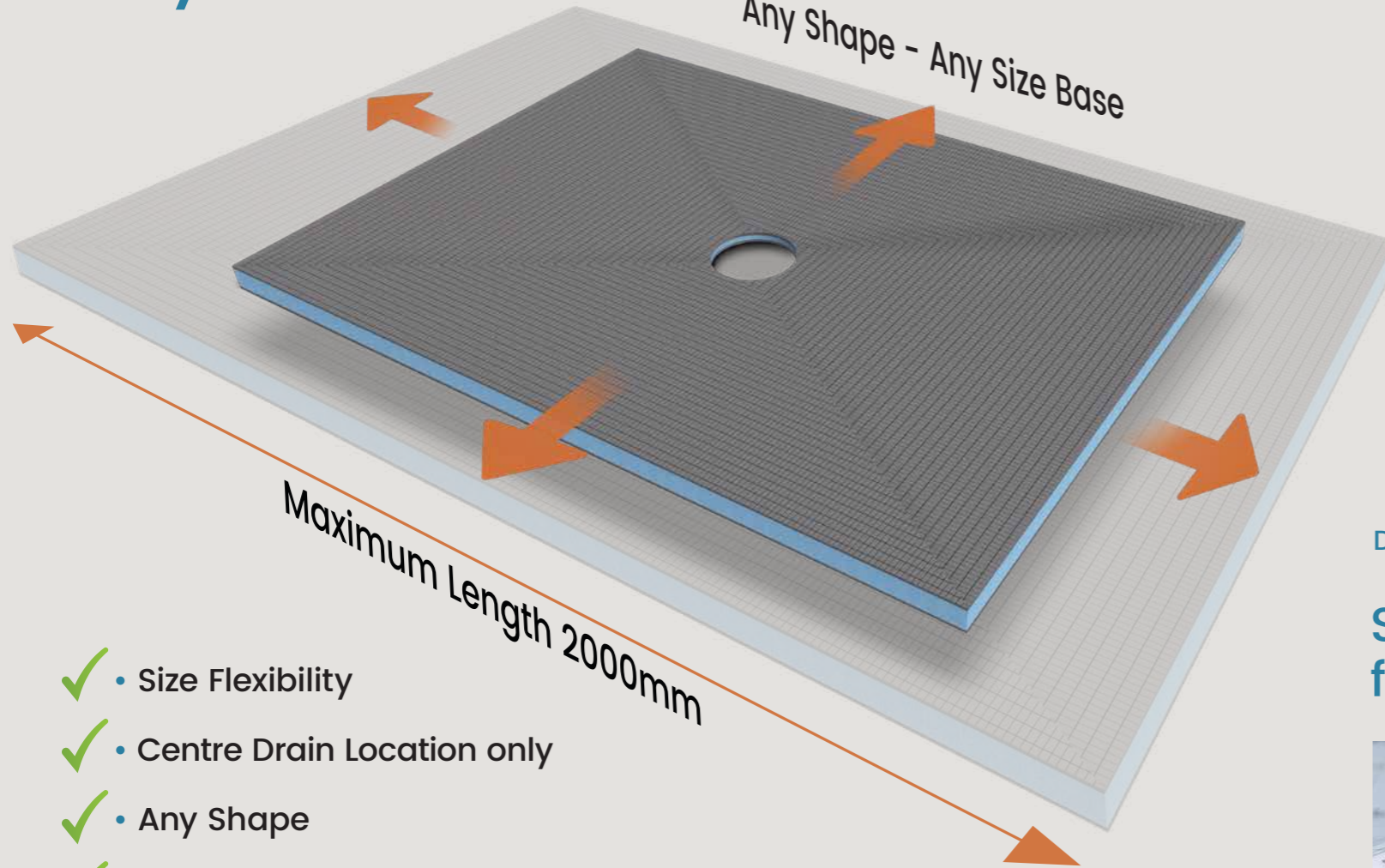

- ✓ • Size Flexibility
- ✓ • Centre Drain Location only
- ✓ • Any Shape
- ✓ • Any Size Custom Base

Rock-Stone® Bases are custom made to your exact dimensions ensuring

A perfect fit every time

Custom design

ORDERING
YOUR
SHOWER

XPS CAD
Base Design



DESIGN EXPERTISE KNOW HOW

Send us your plans
for a Free Quote



ORDER STEPS

- STEP 1 - Call / Email
- STEP 2 - Quote
- STEP 3 - Design
- STEP 4 - Deliver

Rock-Stone® Base Corner Options

ROCK-STONE® BASE AVAILABILITY

● Ex Stock ● Made To Order (5 working days) ● Glass Availability

CORNER - CENTRE OUTLET

Corner Square

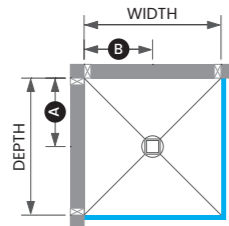
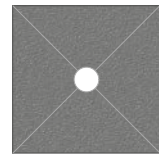

Size	Rock-Stone® Base		Drain Outlet		Base Height	Rebate Depth	Availability
	Depth	Width	A	B			
800 X 800	790	790	405	405	24	26	●
850 X 850	840	840	430	430	24	26	●
900 X 900	890	890	455	455	24	26	●
950 X 950	940	940	480	480	24	26	●
1000 X 1000	990	990	505	505	24	26	●
1050 X 1050	1040	1040	530	530	24	26	●
1100 X 1100	1090	1090	555	555	24	26	●
1150 X 1150	1140	1140	580	580	24	26	●
1200 X 1200	1190	1190	605	605	24	26	●

Corner Rectangle

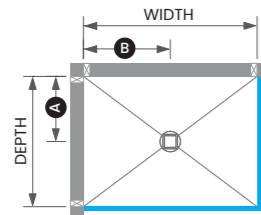
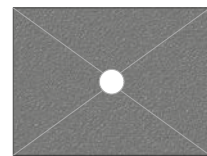

900 X 1200	890	1190	455	605	24	26	●
900 X 1300	890	1290	455	655	24	26	●
900 X 1400	890	1390	455	705	24	26	●
900 X 1500	890	1490	455	755	24	26	●
900 X 1600	890	1590	455	805	24	26	●
900 X 1700	890	1690	455	855	24	26	●
900 X 1800	890	1790	455	905	24	26	●
900 X 1900	890	1890	455	955	30	32	●
900 X 2000	890	1990	455	1005	30	32	●
1000 X 1200	990	1190	505	605	24	26	●
1000 X 1300	990	1290	505	655	24	26	●
1000 X 1400	990	1390	505	705	24	26	●
1000 X 1500	990	1490	505	755	24	26	●
1000 X 1600	990	1590	505	805	24	26	●
1000 X 1700	990	1690	505	855	24	26	●
1000 X 1800	990	1790	505	905	24	26	●
1000 X 1900	990	1890	505	955	30	32	●
1000 X 2000	990	1990	505	1005	30	32	●

Corner Neo-Angle

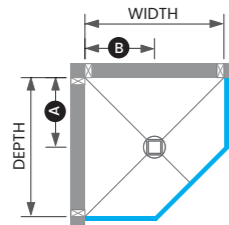
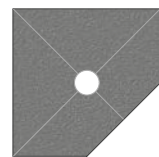

900 X 900	890	890	455	455	24	26	●
950 X 950	940	940	480	480	24	26	●
1000 X 1000	990	990	505	505	24	26	●

Corner J-Walk

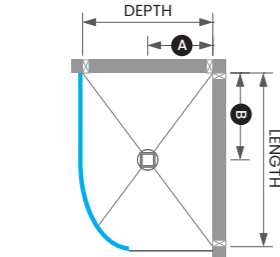
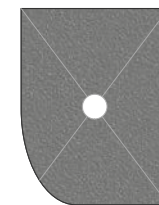

Size	Rock-Stone® Base		Drain Outlet		Base Height	Recess Depth	Availability
	Depth	Length	A	B			
900 X 1250	890	1240	455	630	24	26	●
1000 X 1250	990	1240	505	630	24	26	●

Left Hand Base

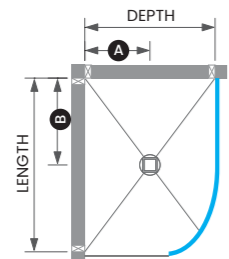
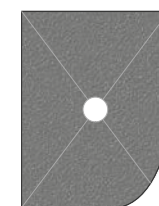

Right Hand Base

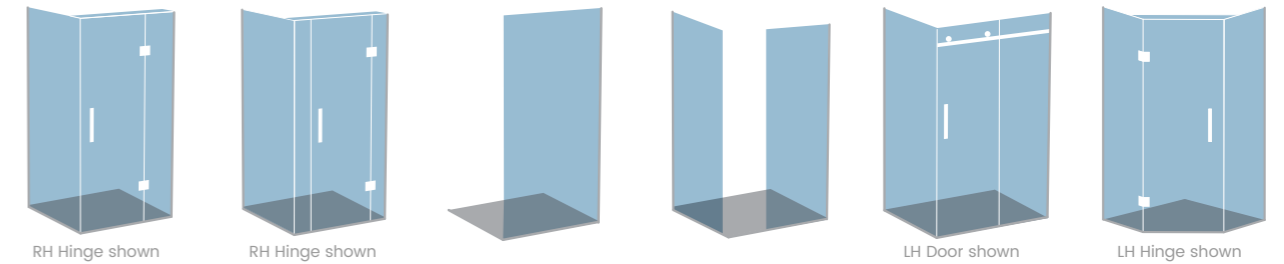

Size	DOOR OFFSET (REVERSIBLE)	DOOR CENTRE (REVERSIBLE)	FIXED PANEL (REVERSIBLE)	WALK-IN (REVERSIBLE)	2-P SLIDING (REVERSIBLE)	DOOR CENTRE (REVERSIBLE)
800 X 800	●	●	●			
850 X 850	●	●	●			
900 X 900	●	●	●			
950 X 950	●	●	●			
1000 X 1000	●	●	●			
1050 X 1050	●	●	●			
1100 X 1100	●	●	●		●	
1150 X 1150	●	●	●		●	
1200 X 1200	●	●	●		●	
900 X 1200	●	●			●	
900 X 1300	●	●			●	
900 X 1400	●	●	●		●	
900 X 1500	●	●	●	●	●	
900 X 1600	●	●	●	●	●	
900 X 1700	●	●	●	●	●	
900 X 1800	●	●	●	●	●	
900 X 1900	●	●	●	●	● 3-PS	
900 X 2000	●	●	●	●	● 3-PS	
1000 X 1200	●	●	●	●	●	
1000 X 1300	●	●	●	●	●	
1000 X 1400	●	●	●	●	●	
1000 X 1500	●	●	●	●	●	
1000 X 1600	●	●	●	●	●	
1000 X 1700	●	●	●	●	●	
1000 X 1800	●	●	●	●	●	
1000 X 1900	●	●	●	●	● 3-PS	
1000 X 2000	●	●	●	●	● 3-PS	
900 X 900						●
950 X 950						●
1000 X 1000						●

WATER DEFLECTOR

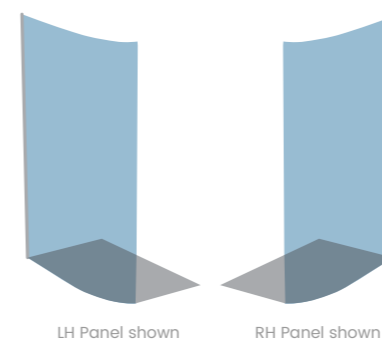

Size	J - WALK-IN	J - WALK-IN
900 X 1250	●	●
1000 X 1250	●	●

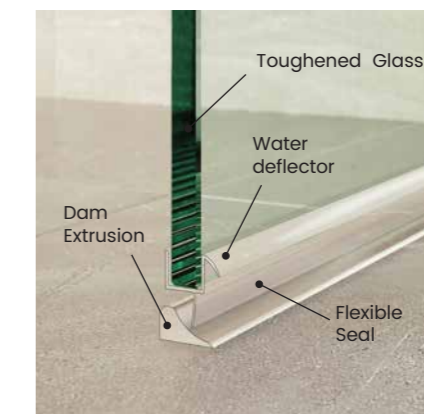

Low profile Dam and flexible seal deflect water back into shower

GLASS ADJUSTMENT

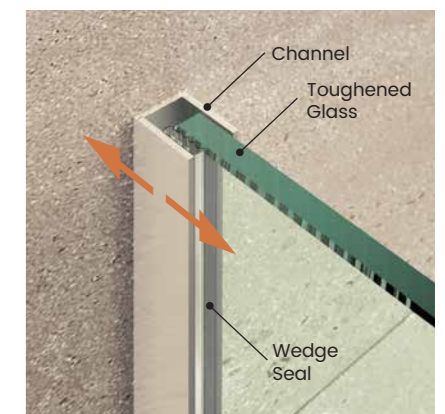

Channel allows glass adjustment for out of square walls (+/- 8 mm)

Rock-Stone® Base Corner Options

ROCK-STONE® BASE AVAILABILITY

● Ex Stock ● Made To Order (5 working days) ● Glass Availability

ALCOVE - CENTRE OUTLET

Alcove Square

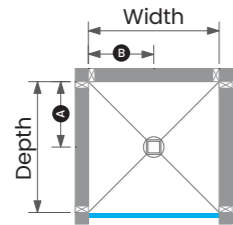
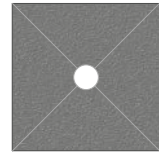

Size	Rock-Stone® Base		Drain Outlet		Base Height	Rebate Depth	Availability
	Depth	Width	A	B			
800 X 800	790	780	405	400	24	26	●
850 X 850	840	830	430	425	24	26	●
900 X 900	890	880	455	450	24	26	●
950 X 950	940	930	480	475	24	26	●
1000 X 1000	990	980	505	500	24	26	●

Alcove Rectangle

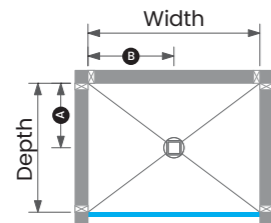
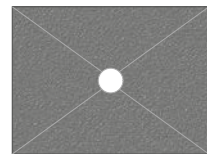

Size	Rock-Stone® Base		Drain Outlet		Base Height	Rebate Depth	Availability
	Depth	Width	A	B			
900 X 1200	890	1180	455	600	24	26	●
900 X 1300	890	1280	455	650	24	26	●
900 X 1400	890	1380	455	700	24	26	●
900 X 1500	890	1480	455	750	24	26	●
900 X 1600	890	1580	455	800	24	26	●
900 X 1700	890	1680	455	850	24	26	●
900 X 1800	890	1780	455	900	24	26	●
900 X 1900	890	1880	455	950	30	32	●
900 X 2000	890	1980	455	1000	30	32	●
1000 X 1200	990	1180	505	600	24	26	●
1000 X 1300	990	1280	505	650	24	26	●
1000 X 1400	990	1380	505	700	24	26	●
1000 X 1500	990	1480	505	750	24	26	●
1000 X 1600	990	1580	505	800	24	26	●
1000 X 1700	990	1680	505	850	24	26	●
1000 X 1800	990	1780	505	900	24	26	●
1000 X 1900	990	1880	505	950	30	32	●
1000 X 2000	990	1980	505	1000	30	32	●

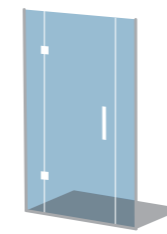

LH Hinge shown

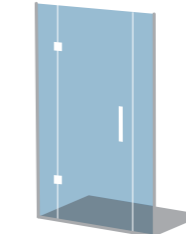

LH Hinge shown

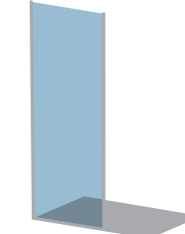

FIXED PANEL (Reversible)

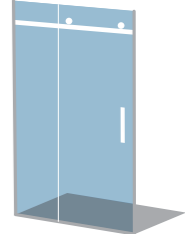

2-P SLIDING (Reversible)

Size	DOOR OFFSET (Reversible)	DOOR CENTRE (Reversible)	FIXED PANEL (Reversible)	2-P SLIDING (Reversible)
800 X 800	●	●		
850 X 850	●	●		
900 X 900	●	●		
950 X 950	●	●		
1000 X 1000	●	●		

900 X 1200	●	●		●
900 X 1300	●	●		●
900 X 1400	●	●		●
900 X 1500	●	●	●	●
900 X 1600	●	●	●	●
900 X 1700	●	●	●	●
900 X 1800	●	●	●	●
900 X 1900	●	●	●	●
900 X 2000	●	●	●	●
1000 X 1200	●	●		●
1000 X 1300	●	●		●
1000 X 1400	●	●		●
1000 X 1500	●	●	●	●
1000 X 1600	●	●	●	●
1000 X 1700	●	●	●	●
1000 X 1800	●	●	●	●
1000 X 1900	●	●	●	● 3-PS
1000 X 2000	●	●	●	● 3-PS

ROUGH-IN SPECIFICATIONS

DIMENSIONS

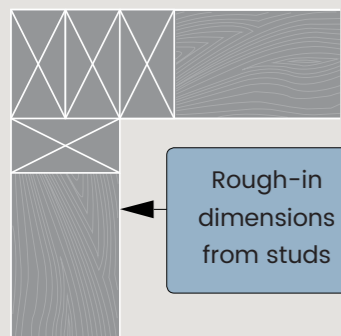

REBATE DEPTH

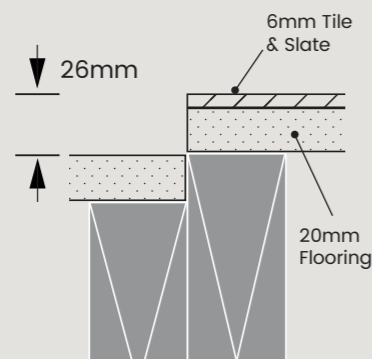

WALL DETAIL

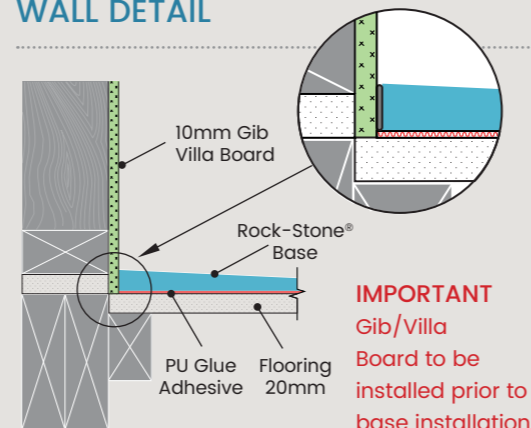

TIMBER FLOOR DETAIL 800>1800mm

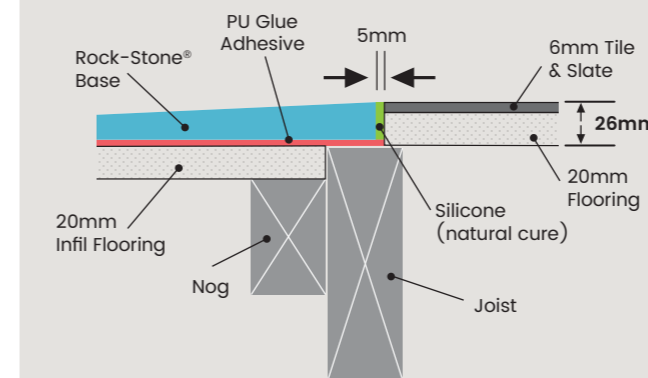

TIMBER FLOOR DETAIL 1800>2000*mm

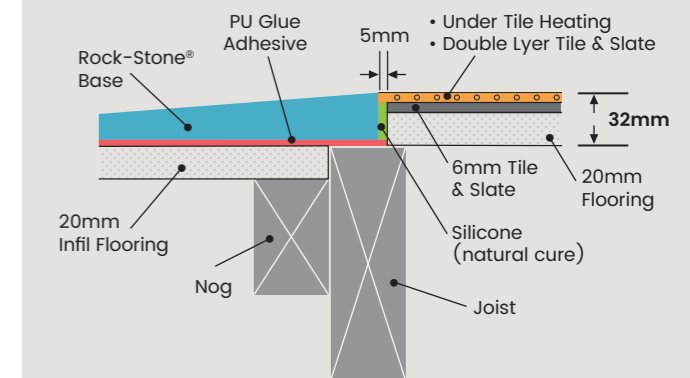

*IMPORTANT Wafer® Bases greater than 1800>2000 length (MAX) will require additional 6mm floor height.

SHOWER MIXER POSITION?

With today's Walk-In showers becoming larger and more popular than ever it is important that the mixer position be considered so the bather can adjust temperature during showering.

After the first minute of showering the body's skin receptors become acclimatised to the original temperature set and requires an incremental increase of 1°C every minute over a two-minute period to eliminate any body cooling effect.

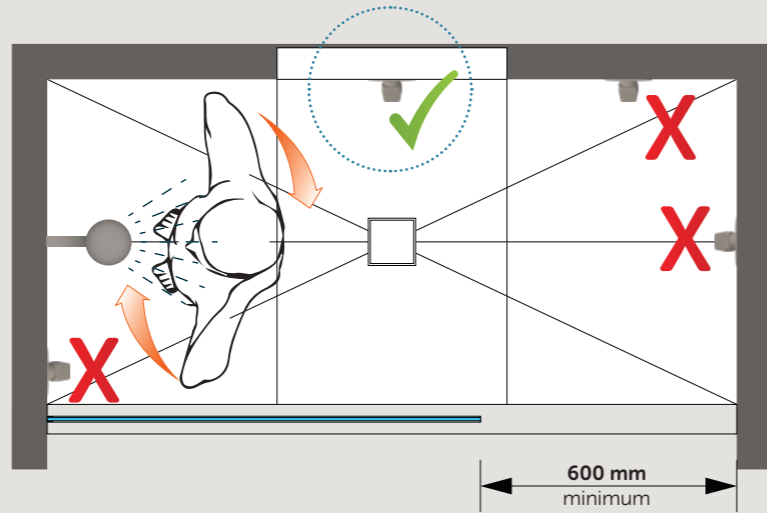

The shower mixer be should be positioned where the bather can easily reach the mixer to adjust water temperature during showering.

SHOWER MIXER & NICHE HEIGHT?

If specifying a recessed shower niche, then you will need to ensure your plumber installs the shower mixer to the recommended height of **1000 mm** off the sub floor allowing sufficient clearance between mixer elbow and niche nog support.

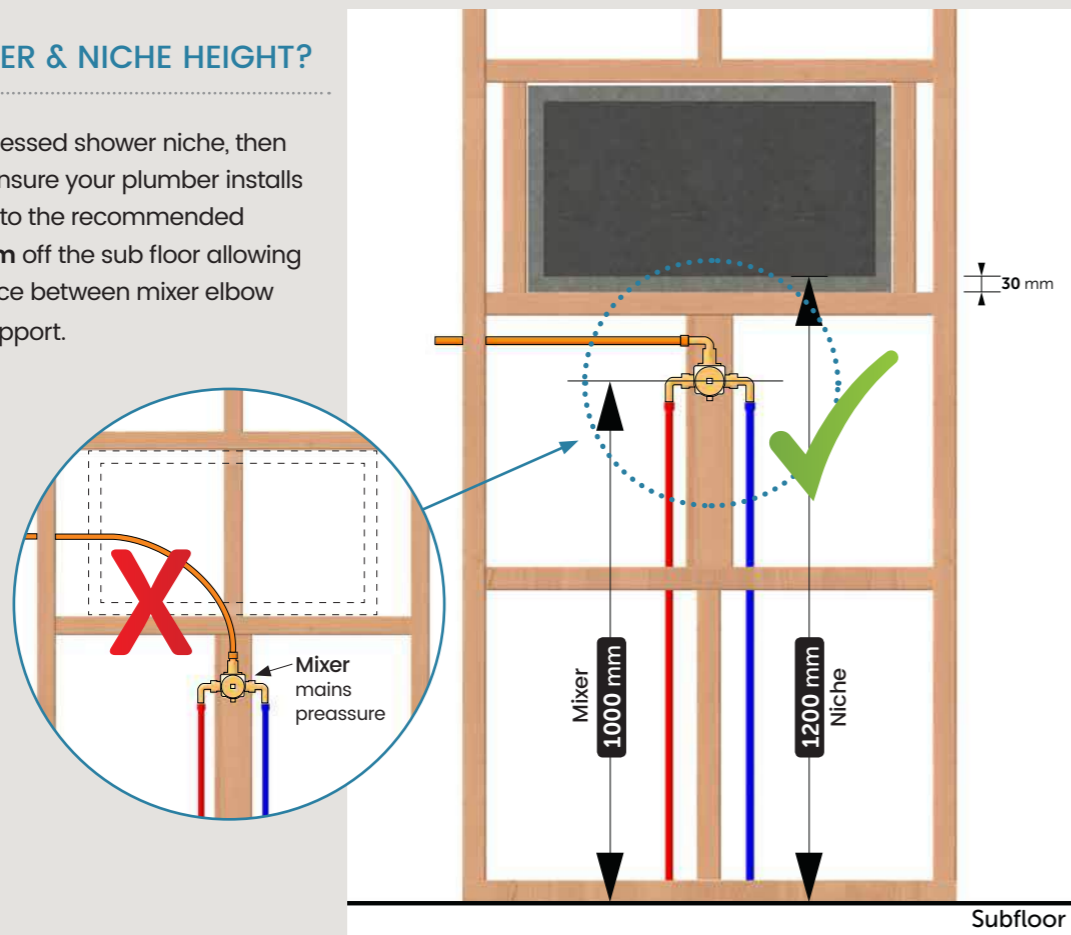

SHOWER NICHE HEIGHT CALCULATION - Wafer Base (Level Entry)

Oben recommends internal niche shelf height is set at **1200 mm off sub floor**. This allows for a 20 mm safety buffer which can be used to raise the niche shelf tile height junction to match the finished wall tile height.

Ask your builder to consult with your tiler regarding your actual shower recess height required as this may vary depending on actual tile size selection, grout joints and tiled floor levels.

Tiles are a nominal size and can vary from actual size advertised. Example 600 X 600 tile may be only 595 X 595.

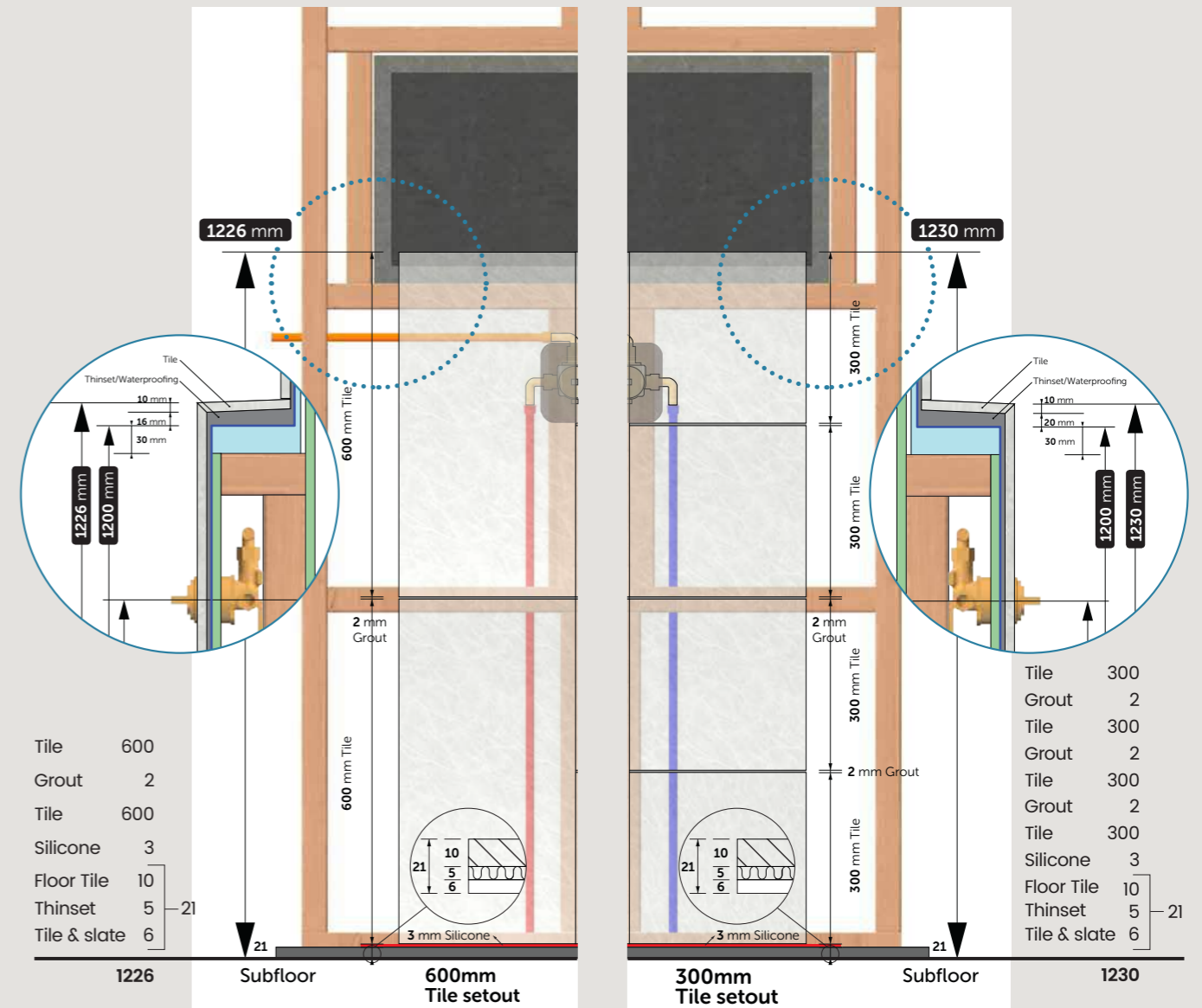

***IMPORTANT**
Above Niche height recommendations are **not suitable for Elusion** channel drain base models as Niche heights vary between models – Please refer to Elusion Brochure

IMPORTANT.

Tile layout dimensions and drawings provided are to be used as a "GUIDE ONLY" and actual niche height must be specified by a tiler in conjunction with your builder in order to determine the niche height required to suit your wall tile selection.

More Oben brochures

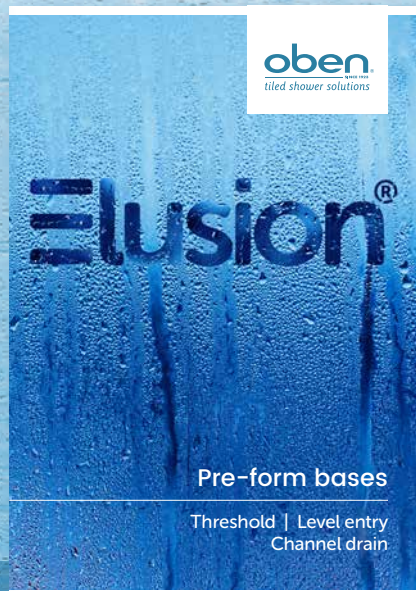

Oben
10.B Parity Place
Hillcrest
Auckland 0627
T 09 44 33 879
E sales@oben.co.nz
W www.oben.co.nz

Oben reserves all rights to alter designs and specification without notice. All dimensions given are approximate and should be checked prior to installation. Products shown in Catalogues, Order Forms and digital format are subject to Intellectual Property Protection. NZ and International Patents Pending. ® Registered Trademarks of Oben. Oben's continuous product improvement policy means some product enhancements may not be available at time of order placement due to current stock and phasing in/out of new models.

Quotations valid 30 days from date of quote. Prices subject to re quote after expiry of 30 days. Prices quoted are subject to final site measure. (Contact Oben Customer Service for further details.) Tapware & Accessories featured in photography are not included.

oben
SINCE 1923
tiled shower solutions

•Design •Quality •Service

All products available Ex Oben warehouse Auckland and do not include shipping & handling costs which will be charged separately on invoices. Custom made to order products are Non-Refundable.

© Oben wafer® Brochure April 2019