

**oben**<sup>®</sup>  
SINCE 1923  
*tiled shower solutions*

**elusion**<sup>®</sup>

**Pre-form bases**

---

Level entry | Threshold  
**Channel Drain**



## Oben history

Since 1923 Oben's family founders have been passionate about creating the perfect bathroom a place where water and wonderful ideas flow together in endless expressions of innovation, indulgence and design.

For over 95 years this proud family-owned business has dedicated itself to being first with the future and second-to-none with everything else!

It's an attitude that has made Oben an undisputed market leader and earned it an envied international reputation as a modern day pioneer of bathroom and showering technology.

Oben's innovative shower products are built with the same solidity, durability and quality as their reputation so that you may enjoy the pleasure of their performance and beauty of their designs for many years to come.



**Derek Englefield**

Managing Director



## Contents

J Walk-In Shower - Curved	6 - 7
Walk-In Shower - Flat	8 - 9
Slide Showers	10 - 11
Rectangular Corner Showers	12 - 13
Square Corner Showers	14 - 15
Alcove Showers	16 - 17
Neo-Angle Showers	18 - 19
Black Line® Showers	20 - 21
Shower Niches / Foot Rest	22 - 23
Glide Glass® Easy Clean	24
Product Finishes / Warranty	25
Rock-Stone® Features & Benefits	26 - 27
Ξlusion® Channel Drain	28 - 29
Rock-Stone® Base Adhesive Kits	30 - 31
Rock-Stone® Custom Made to Order	32 - 33
Rock-Stone® Level Entry Installation	34 - 35
Rock-Stone® Level Entry Technical	36 - 41
Rock-Stone® Threshold Installation	42 - 43
Rock-Stone® Threshold Technical	44 - 48
Ξlusion® Channel Drain Order Form	49
Niche Technical Specifications	50
Niche Installation	51
Ξlusion® F.A.Q.'s	52
Ξlusion® Niche Height Calculations	53

New build or renovating

A photograph of a person's legs standing in a modern shower. The shower has a grey tiled floor and walls. A black channel drain is visible on the floor. The person is standing on the drain. The text is overlaid on the right side of the image.

It's never  
been easier  
to create an ultra-modern  
channel drain shower

---

with Oben Elusion®

# Oben makes it easy

Tiler

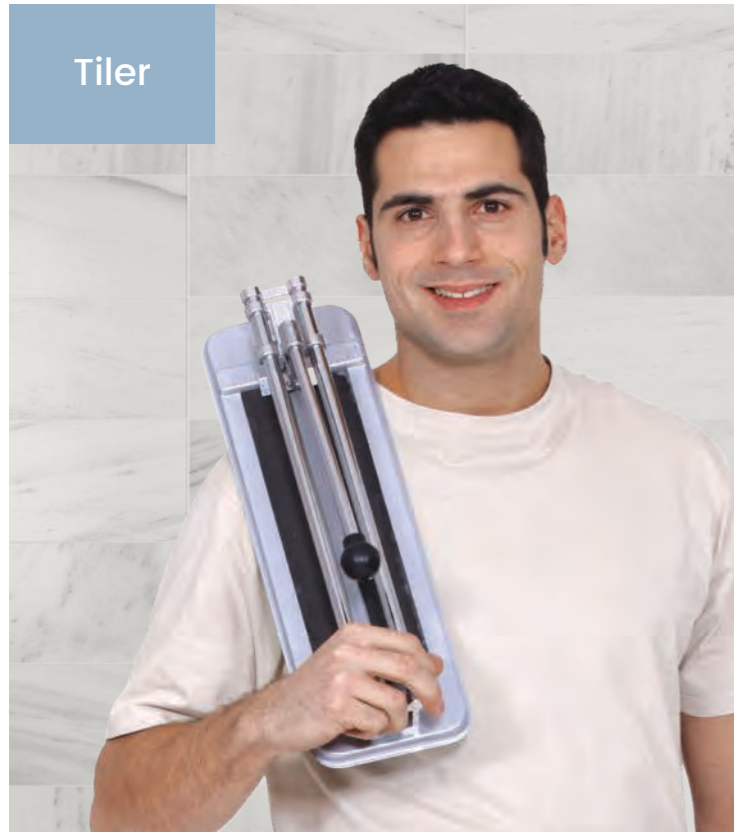

*“Oben makes it easy for me to create an exquisite tile shower, every time”*

Oben technology - everything a tiler could wish for

- **100% Waterproof** shower base system
- Pre-formed slopes **guarantee drainage**
- **Rock-Solid** - no chance of movement
- Compatible with **any** waterproofing system
- Easy and fast to tile - **no crowning**

*“With Oben behind us, we say “yes” to every shower request”*

Quality and Service you can rely on

Builder



- **Established brand** since 1923
- High quality products you can **trust & depend** on
- Design solutions for **every shape** of shower
- **On time deliveries** - each time - every time!
- Hassle-free factory **installation service**

Home owners

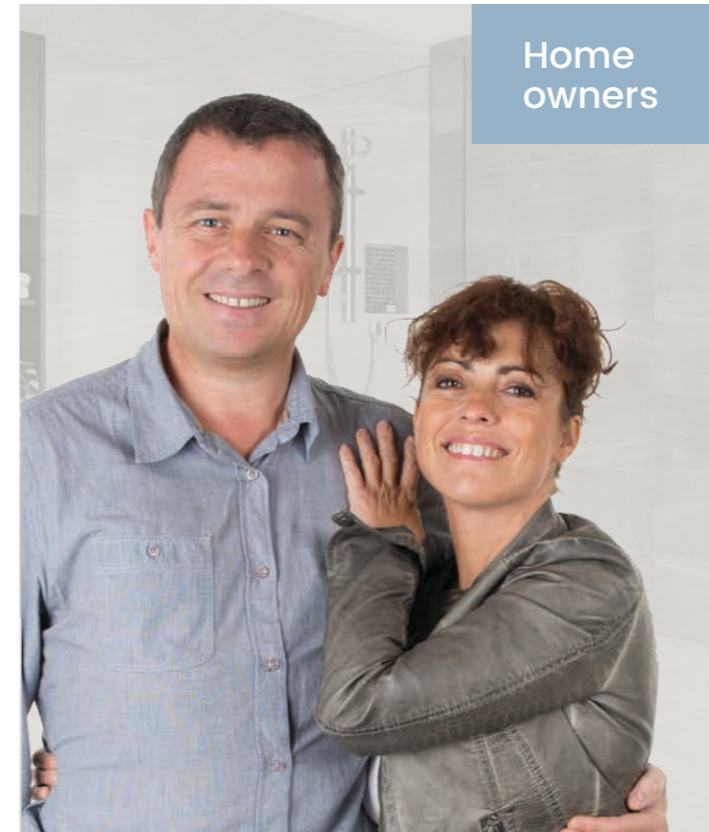

*“The whole experience of designing one of the most important areas in our home has been a breeze with Oben”*

- Oben brochures **makes it easy!**
- **“Peace of Mind”** - 25 year Leak Proof Guarantee
- Full range of tile showers - **Any Shape, Any Size**
- **Total package** - Drains, Base and Frameless Glass
- A choice for **Level Entry** and **Hob** options

*“Oben, their precision in design and their history in the market says it all!”*

Architect



- Oben brand - totally **dependable** and trustworthy
- Tiled shower solutions for **new** and **renovations**
- Oben offers the ultimate in **versatility** and luxury
- Sleek minimalist designs - **Function with style**
- Oben enables us to **design** any custom shower

Indulge - Elusion®

## Elusion® Base J-Walk-In Options

### CORNER J-WALK-IN

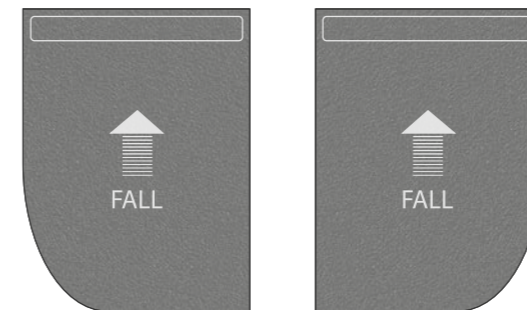

Left Hand Base  
Back Drain

Right Hand Base  
Back Drain

LENGTH X WIDTH
1250 X 900 LH
1250 X 900 RH
1250 X 1000 LH
1250 X 1000 RH

### ENCLOSURE - FRAMELESS GLASS



LH PANEL

RH PANEL

### FEATURES - Enclosure

- 8 mm Toughened Safety glass
- Curved LH & RH Glass Panels
- No stabilizing bar required
- Clear glazing
- Glass Height 1960 (Standard)
- 15mm adjustment for out of true walls
- Glass Panel Length 1250

### FEATURES - Elusion® Base

- Designed for Timber & Concrete floor installations
  - Pre-formed slopes guarantee drainage
  - Rock-Stone® base system 100% Waterproof
  - Easy and fast to tile (flat planes)
  - Minimalistic **Level Entry** design
  - Compatible with any Certified Waterproofing system
  - Base Adhesive Kit included:
    1. **Polyurethane Kit** (Timber Floors)
    2. **Tile Adhesive Kit** (Concrete Floors)
  - Drain - J Gully Drain 80 x 50 and Channel Drain sold separately
  - Not available in Threshold Base option
- Base Hand must be specified at time of order

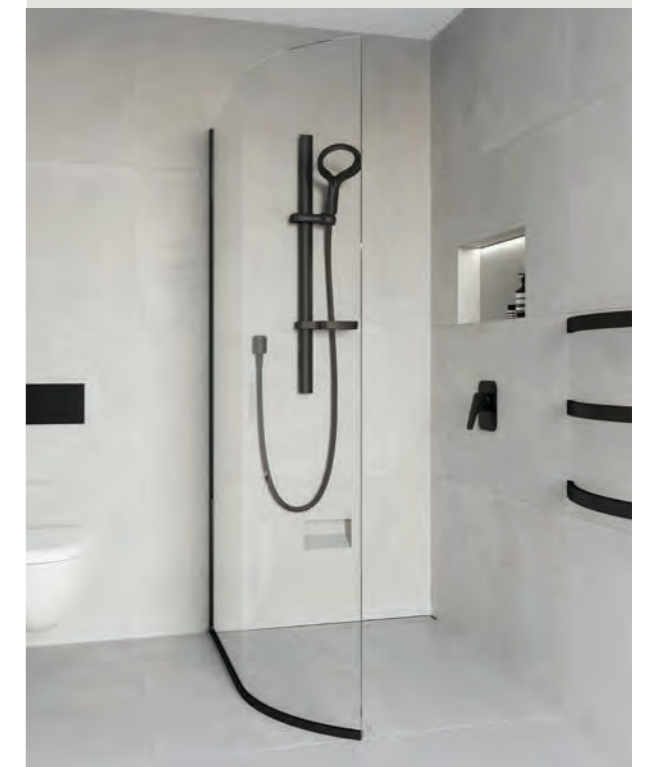

The ultimate in  
versatility and luxury

Step into luxury with the new range of Oben Walk-in free standing glass panels which do not require an overhead stabilising bar. The simplicity of a single sheet of toughened glass panel creates a luxurious Walk-In shower in any bathroom, the ease of walking into your shower with a level entry profile and no doors to negotiate needs little explanation.

Shower finish illustrated in Matt Black. LH Base / Back Drain

Imagine - Elusion®



The ultimate in versatility and luxury

Step into luxury with the new range of Oben Walk-in free standing glass panels which do not require an overhead stabilising bar. The simplicity of a single sheet of toughened glass panel creates a luxurious Walk-In shower in any bathroom, the ease of walking into your shower with a low threshold profile and no doors to negotiate needs little explanation.

Shower finish illustrated in Matt Black. LH Drain

## Elusion® Base Walk-In Options

### CORNER RECTANGLE

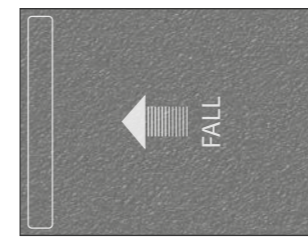

LH Drain



Back Drain

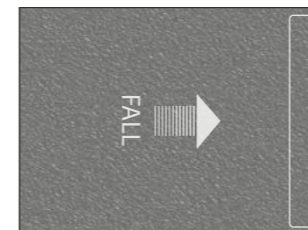

RH Drain

DEPTH X WIDTH
900 X 1000
900 X 1100
900 X 1200
900 X 1300
900 X 1400
900 X 1500
900 X 1600
900 X 1700
900 X 1800
900 X 1900
900 X 2000

1000 X 1100
1000 X 1200
1000 X 1300
1000 X 1400
1000 X 1500
1000 X 1600
1000 X 1700
1000 X 1800
1000 X 1900
1000 X 2000

### ENCLOSURE - FRAMELESS GLASS

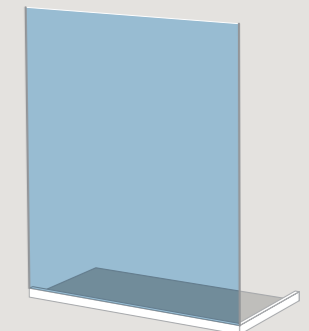

FIXED PANEL

### FEATURES - Enclosure

- 10mm Toughened Safety Glass
- Reversible Left and Right Hand Panels
- No stabilising over panel required
- Glass height - 1960 (Standard)
- Custom glass height - Made to Order
- Glass Panel Width (Standard) 900, 950, 1000, 1100, 1200

### FEATURES - Elusion® Base

- Designed for Timber & Concrete floor installations
- Pre-formed slopes guarantee drainage
- Rock-Stone® base system 100% Waterproof
- Easy and fast to tile (flat planes)
- Available in **Ultra Low Threshold** or Minimalistic flush **Level Entry** design
- Compatible with any Certified Waterproofing system
- Base Adhesive Kit included:
  1. **Polyurethane Kit** (Timber Floors)
  2. **Tile Adhesive Kit** (Concrete Floors)
- Drain - J Gully Drain 80 x 50 and Channel Drain sold separately

Drain position must be specified at time of order



Threshold model



Let yourself be inspired

The latest in minimalistic 10mm glass makes the slide shower an impressive design statement. Extra smooth stainless steel roller technology provides for smooth and effortless door opening and closing action. Minimalistic in appearance, this modern frameless sliding glass enclosure provides that truly "Frameless look" and is the flagship of the Oben shower range.

Shower finish illustrated in Matt Black. Back Drain

SLIDE SHOWER

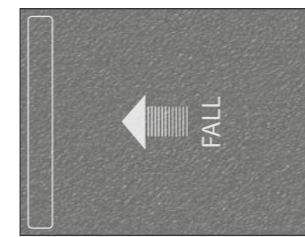

LH Drain



Back Drain

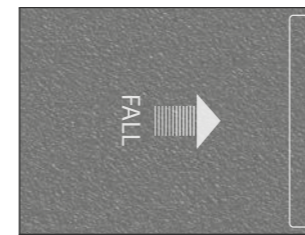

RH Drain

DEPTH X WIDTH
900 X 1100
900 X 1200
900 X 1300
900 X 1400
900 X 1500
900 X 1600
900 X 1700
900 X 1800
900 X 1900
900 X 2000

1000 X 1100
1000 X 1200
1000 X 1300
1000 X 1400
1000 X 1500
1000 X 1600
1000 X 1700
1000 X 1800
1000 X 1900
1000 X 2000

ENCLOSURE – FRAMELESS GLASS

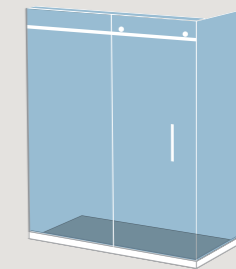

2 PANEL SLIDING DOOR  
RH Door Shown

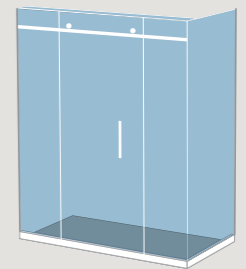

3 PANEL SLIDING DOOR  
RH Door Shown

FEATURES – Enclosure

- 10mm Toughened Safety Glass
- Reversible Left and Right Hand Doors
- Easy glide Stainless Steel roller wheels
- Glass height – 2050 (Standard)
- Custom glass height – Made to Order
- Available in Corner or Alcove options  
Size Range 1200 – 2000

FEATURES – Elusion® Base

- Designed for Timber & Concrete floor installations
- Pre-formed slopes guarantee drainage
- Rock-Stone® base system 100% Waterproof
- Easy and fast to tile (flat planes)
- Available in **Ultra Low Threshold** or Minimalistic flush **Level Entry** design
- Compatible with any Certified Waterproofing system
- Base Adhesive Kit included:
  1. **Polyurethane Kit** (Timber Floors)
  2. **Tile Adhesive Kit** (Concrete Floors)
- Drain – J Gully Drain 80 x 50 and Channel Drain sold separately

Drain position must be specified at time of order



Threshold model



Extra Large for Showering Luxury

Corner frameless shower opens up a room to allow light to flow in, transforming ordinary bathrooms into inspirational and relaxing spaces. The rectangular corner has an offset door to allow for the widest possible entrance with 10mm solid frameless glass for that luxurious feel.

Shower finish illustrated in Matt Black. LH Drain

## CORNER RECTANGLE

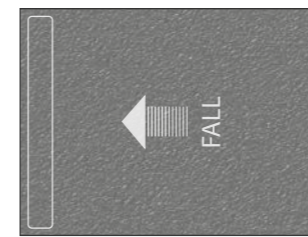

LH Drain



Back Drain

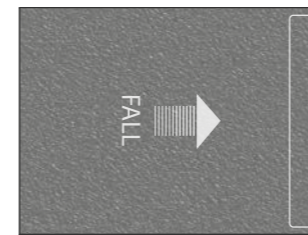

RH Drain

DEPTH X WIDTH
900 X 1000
900 X 1100
900 X 1200
900 X 1300
900 X 1400
900 X 1500
900 X 1600
900 X 1700
900 X 1800
900 X 1900
900 X 2000

1000 X 1100
1000 X 1200
1000 X 1300
1000 X 1400
1000 X 1500
1000 X 1600
1000 X 1700
1000 X 1800
1000 X 1900
1000 X 2000

## ENCLOSURE - FRAMELESS GLASS

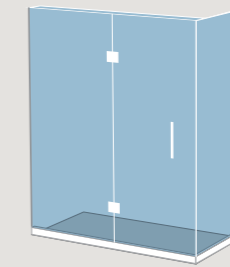

OFFSET DOOR  
LH Hinge Shown

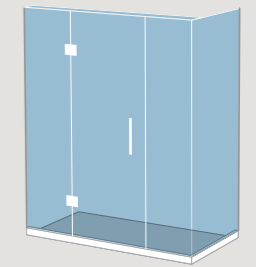

CENTRE DOOR  
LH Hinge Shown

## FEATURES - Enclosure

- 10mm Toughened Safety Glass
- Reversible Left and Right Hand Doors
- Door width 690mm (590mm optional)
- Centre and Offset door options
- Glass Over Panel (Standard)
- Glass height - 1960 (Standard)
- Custom glass height - Made to Order
- Glass Panel Width (Standard) 900 - 2000mm

## FEATURES - Elusion® Base

- Designed for Timber & Concrete floor installations
- Pre-formed slopes guarantee drainage
- Rock-Stone® base system 100% Waterproof
- Easy and fast to tile (flat planes)
- Available in **Ultra Low Threshold** or Minimalistic flush **Level Entry** design
- Compatible with any Certified Waterproofing system
- Base Adhesive Kit included:
  1. **Polyurethane Kit** (Timber Floors)
  2. **Tile Adhesive Kit** (Concrete Floors)
- Drain - J Gully Drain 80 x 50 and Channel Drain sold separately

Drain position must be specified at time of order



Threshold model





Adding new dimension to space

Oben's unique Square Corner features a glass return wall which gives the appearance of added space and light, bringing a whole new dimension to your bathroom. Manufactured from 10mm toughened safety glass with a single door available in left or right hand options, also featuring a low profile threshold for that minimalist look.

Shower finish illustrated in Matt Black. LH Drain

CORNER SQUARE

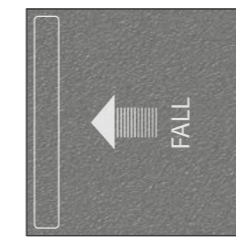

LH Drain



Back Drain

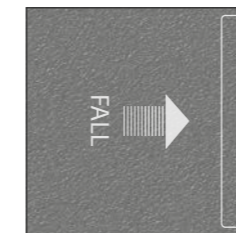

RH Drain

DEPTH X WIDTH
800 X 800
850 X 850
900 X 900
950 X 950
1000 X 1000
1050 X 1050
1100 X 1100
1150 X 1150
1200 X 1200

ENCLOSURE – FRAMELESS GLASS

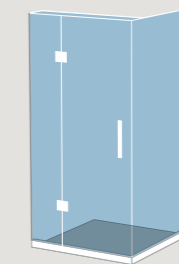

OFFSET DOOR  
LH Hinge Shown

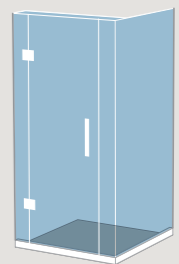

CENTRE DOOR  
LH Hinge Shown

FEATURES – Enclosure

- 10mm Toughened Safety Glass
- Reversible Left and Right Hand Doors
- Door width 690mm (590mm optional)
- Centre and Offset door options
- Glass Over Panel (Standard)
- Glass height - 1960 (Standard)
- Custom glass height - Made to Order

FEATURES – Elusion® Base

- Designed for Timber & Concrete floor installations
- Pre-formed slopes guarantee drainage
- Rock-Stone® base system 100% Waterproof
- Easy and fast to tile (flat planes)
- Available in **Ultra Low Threshold** or Minimalistic flush **Level Entry** design
- Compatible with any Certified Waterproofing system
- Base Adhesive Kit included:
  1. **Polyurethane Kit** (Timber Floors)
  2. **Tile Adhesive Kit** (Concrete Floors)
- Drain – J Gully Drain 80 x 50 and Channel Drain sold separately

Drain position must be specified at time of order



Threshold model

# Invigorate - Elusion®

Maximise your bathroom space

Oben's elegant Alcove recessed design, not only gives a great internal showering area without taking up additional space, it also opens up new design possibilities. Create your own personalised shower environment, enabling additional space and movement within the bathroom. A sleek and luxurious recessed shower with minimalist threshold provides both function and style.

Shower finish illustrated in Matt Black. Back Drain

## Elusion® Base Alcove Options

### ALCOVE

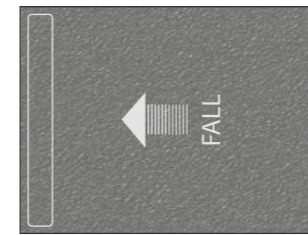

LH Drain



Back Drain

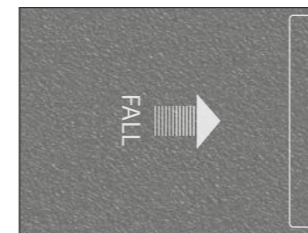

RH Drain

### DEPTH X WIDTH

900 X 900

1000 X 1000

900 X 1000

900 X 1100

900 X 1200

900 X 1300

900 X 1400

900 X 1500

900 X 1600

900 X 1700

900 X 1800

900 X 1900

900 X 2000

1000 X 1100

1000 X 1200

1000 X 1300

1000 X 1400

1000 X 1500

1000 X 1600

1000 X 1700

1000 X 1800

1000 X 1900

1000 X 2000

### FEATURES - Elusion® Base

- Designed for Timber & Concrete floor installations
- Pre-formed slopes guarantee drainage
- Rock-Stone® base system 100% Waterproof
- Easy and fast to tile (flat planes)
- Available in **Ultra Low Threshold** or Minimalistic flush **Level Entry** design
- Compatible with any Certified Waterproofing system
- Base Adhesive Kit included:
  1. **Polyurethane Kit** (Timber Floors)
  2. **Tile Adhesive Kit** (Concrete Floors)
- Drain - J Gully Drain 80 x 50 and Channel Drain sold separately

Drain position must be specified at time of order

### ENCLOSURE - FRAMELESS GLASS

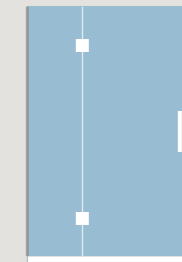

\*OFFSET DOOR  
LH Hinge Shown

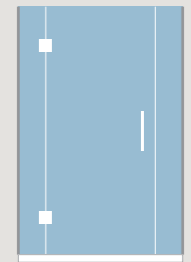

\*CENTRE DOOR  
LH Hinge Shown

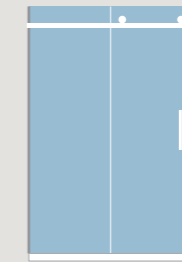

2P SLIDING DOOR  
RH Door Shown

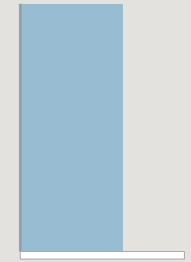

FIXED PANEL  
LH Panel Shown

### FEATURES - Enclosure

- Glass Height:
  - Hinge Model 1960mm
  - Door Width 690 / 590mm
  - Sliding Model 2050mm
- Custom glass height - Made to Order

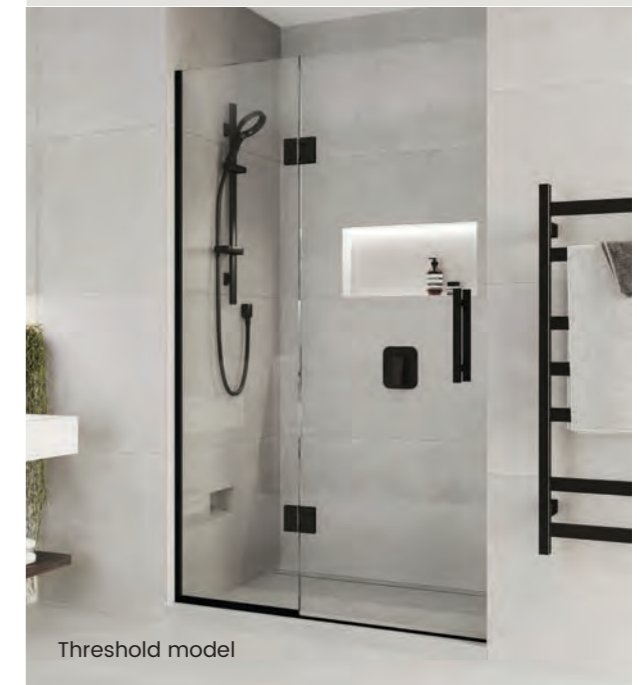

Threshold model

Enjoy – Elusion®

## Elusion® Base Neo-Angle Options

### NEO-ANGLE CORNER

DEPTH X WIDTH

900 X 900

950 X 950

1000 X 1000

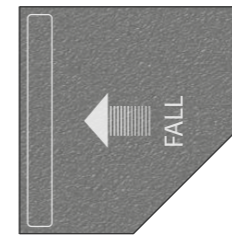

LH Drain

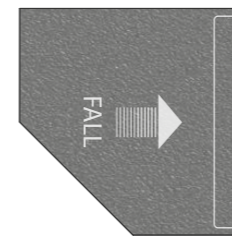

RH Drain

### ENCLOSURE – FRAMELESS GLASS

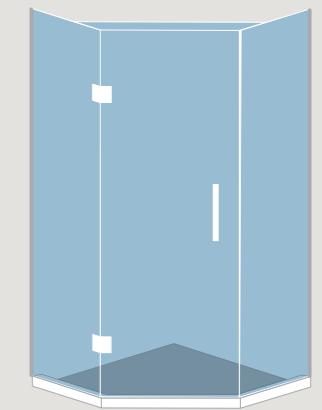

CENTER DOOR  
LH Hinge Shown

### FEATURES – Enclosure

- Reversible Left and Right Hand Doors
- Door width 690mm (590mm optional)
- Glass Over Panel (Standard)
- Glass height - 1960 (Standard)
- Custom glass height - Made to Order

### FEATURES – Elusion® Base

- Designed for Timber & Concrete floor installations
- Pre-formed slopes guarantee drainage
- Rock-Stone® base system 100% Waterproof
- Easy and fast to tile (flat planes)
- Available in **Ultra Low Threshold** or Minimalistic flush **Level Entry** design
- Compatible with any Certified Waterproofing system
- Base Adhesive Kit included:
  1. **Polyurethane Kit** (Timber Floors)
  2. **Tile Adhesive Kit** (Concrete Floors)
- Drain - J Gully Drain 80 x 50 and Channel Drain sold separately

Drain position must be specified at time of order



Threshold model

Where space is  
a luxury

Oben's practical, space saving Neo Angle corner shower not only maximises space, it also makes the most out of what you can do in a space devoted entirely to indulgence, relaxation and wellbeing. Neo Angle is made from 10mm frameless toughened safety glass and comes with a single door in left or right hand options.

Shower finish illustrated in Matt Black. LH Drain

# Black-Line® – Lattice



Industrial, Stylish and Metropolitan

Make an impact in your bathroom with Oben Black-Line® Lattice Collection. Designed to stand out as a bold centerpiece, the Lattice collection draws inspiration from the industrial age, bringing an industrial chic to your bathroom.

Shower finish illustrated in Matt Black. LH Drain

## Black-Line® Lattice

This sleek new addition **Oben Black-Line®** collection is made from slimline anodised matt black aluminium frames. The black lattice effect is digitally printed on to the glass with ceramic ink and becomes permanently fused into the glass surface when toughened; making the glass much easier to clean and maintain due to the smooth inside glass finish.

### LATTICE – WALK-IN (FLAT PANEL)

#### FEATURES AND BENEFITS

- Height - 2000mm
- Anodized aluminium frame Matt Black finish
- No stabilising bar required
- Size availability - 900, 1000, 1200, 1400, 1500mm

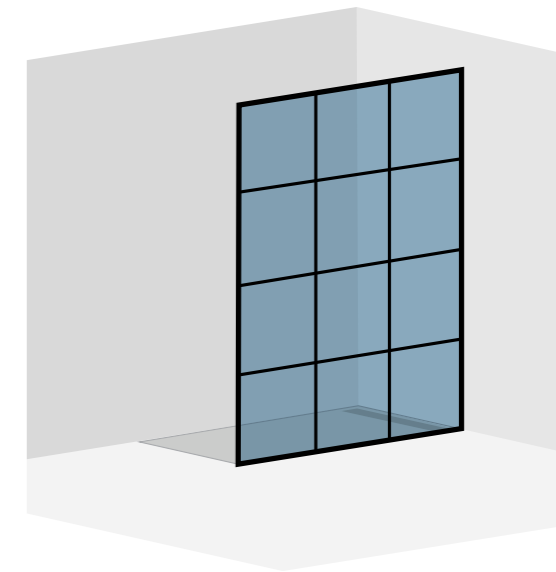

### LATTICE – WALK-IN (CORNER)

#### FEATURES AND BENEFITS

- Height - 2000mm
- Anodized aluminium frame Matt Black finish
- No stabilising bar required
- Fixed panel size - 900, 1000, 1200, 1400, 1500mm
- Return panel size - 800, 900, 1000mm

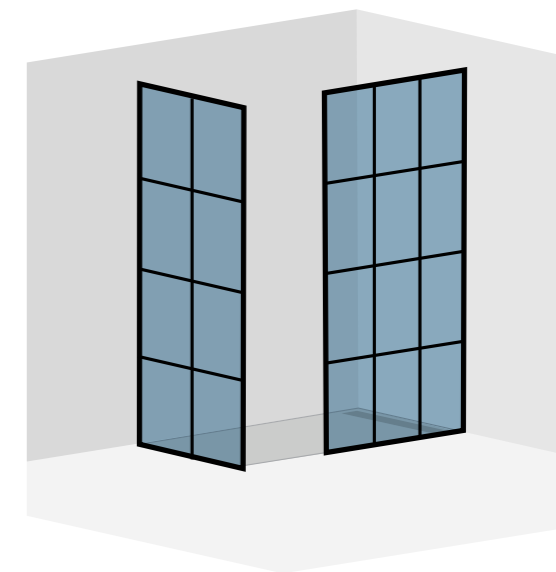

### LATTICE – CORNER SQUARE & RECTANGLE

#### FEATURES AND BENEFITS

- Height - 2000mm
- Anodized aluminium frame Matt Black finish
- Overhead Stabilising channel
- Square - 900 x 900, 1000 x 1000mm
- Rectangle - 900 x 1200, 1400, 1500mm  
1000 x 1200, 1400, 1500mm

Custom sizes and glass configurations available on request. Contact Oben Customer Service 09 44 33 879 for further details

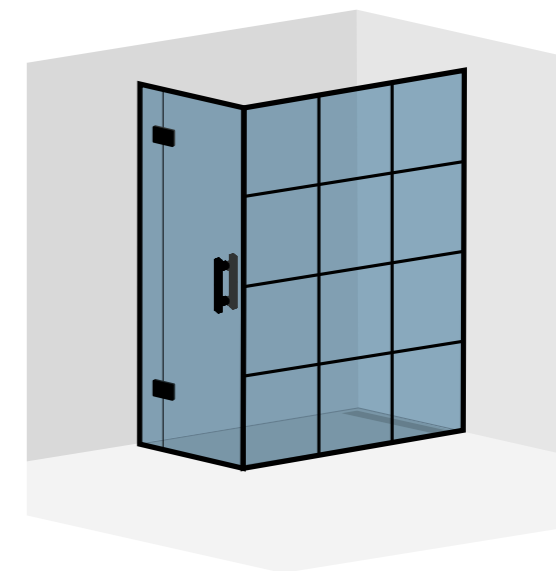

# Shower niches

When remodelling a bathroom, consider adding a recessed shower niche into your design. It's a practical and streamlined way to add storage space for shampoos, soaps and accessories within your shower wall cavity, without taking away valuable elbow room.

Oben built-in recessed shower niches are a great alternative to chunky glass corner shelves and shower caddies. Available in a wide range of shapes and sizes to suit every installation.



MITRED EDGE



TILE TRIM



## EXTERNAL EDGE FINISHES

A mitred tile edge will give your niche that professional stylish designer look. Ask your tiler to quote mitred edges, which is where the tiles are cut on a 45-degree angle so that the tile edges meet therefore eliminating the necessity for tile trims. Alternatively aluminium tile trim extrusions are available in a range of finishes.

## FOOT REST

Oben's recessed Foot Rest offers a practical solution to shave your legs easily and safely in the shower.



## LIGHT BOX® NICHE 600 X 300

Adding a wall niche is a very practical and elegant way to create more storage space in your bathroom. Recessed wall niches enhance your bathroom design and provide a place to conveniently stow all your shampoos, shower gels and other shower items. Available in a range of sizes to match any bathroom style.

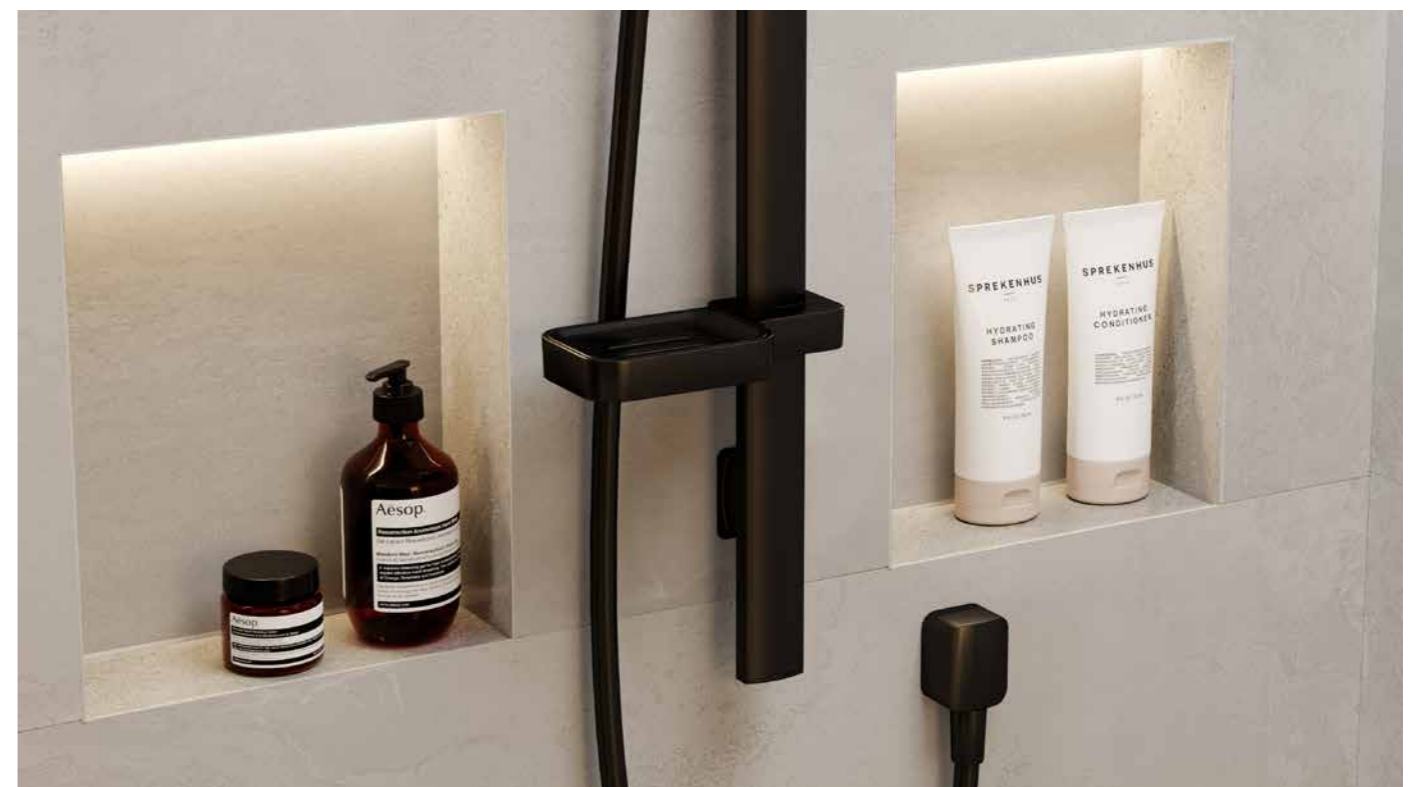

## LIGHT BOX® NICHE 300 X 300

Accessories as shown not included

# What is Glide Glass®

## THE NON-STICK EASY-CLEAN GLASS

Glide Glass® is proprietary protective nano coating developed by Oben.

A long lasting protective coating for glass showers, making glass easier to clean and maintain like new.

Glide Glass reduces cleaning time by repelling lime scale and soap residue deposits from adhering to the glass surface, which results in significantly reduced time and effort for cleaning.

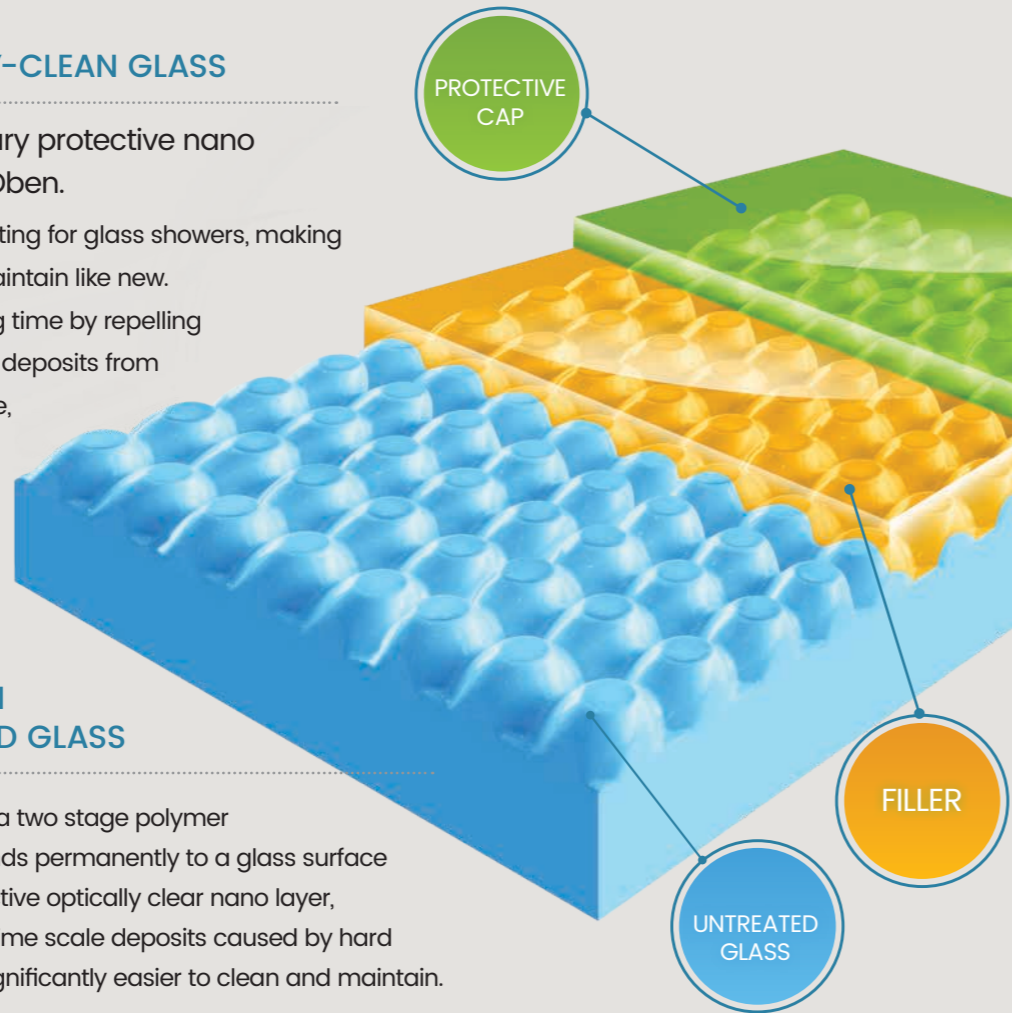

## WHAT IS THE DIFFERENCE BETWEEN TREATED & UNTREATED GLASS

Glide Glass® treated glass is a two stage polymer chemical reaction which bonds permanently to a glass surface providing an ultra thin protective optically clear nano layer, resistant to soap scum and lime scale deposits caused by hard water, making the surface significantly easier to clean and maintain.

## Makes glass easier to clean and maintain like new.

- Highly water repellent (Hydrophobic)
- Resistant to Hard water
- Less frequent cleaning
- Reduces mould & bacteria build up

UNTREATED GLASS

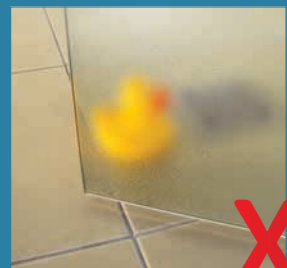

TREATED GLASS

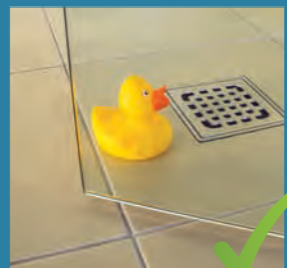

## Glide Glass®

Keeps your frameless glass shower looking like new!



NON-STICK, EASY-CLEAN GLASS

**Glide Glass®** - Optional Extra, only available for **NEW** glass installations and must be specified at time of frameless glass shower order.

Average price for **Glide Glass®** Nano application per shower approximately \$150 - \$350 depending on shower size, includes Consumer Care & Maintenance Kit.

# Product Finishes

## HANDLES

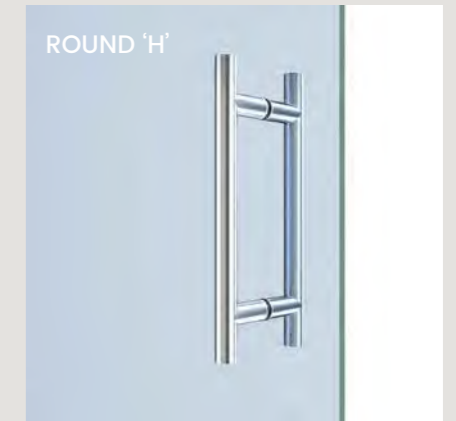

## HINGES



## FINISHES



**CHROME**  
Standard

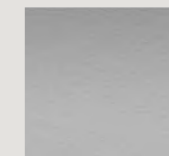

**SATIN**  
\*Non-Standard

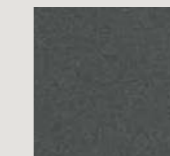

**GUNMETAL**  
\*Non-Standard

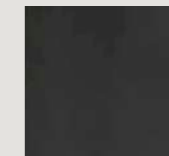

**MATT BLACK**  
\*Non-Standard



**BRUSHED NICKEL**  
\*Non-Standard

### Note:

- \* Surcharge applies to non-standard finishes
- \* Not all showers available in non-standard finishes

## OBEN PRODUCT WARRANTY SCHEDULE

CATEGORY	NON COMMERCIAL USE
Rock-Stone® Shower Bases	25 Year
Rock-Stone® Niches	25 Year
Rock-Stone® Hobs	25 Year
Shower Drains	15 Year (Excludes powder-coated finishes*)
Showers (Glass & Hardware)	5 Year
Mirrors	1 Year (Excludes mirrors installed directly onto a vanity top)
Shower Seals (Vinyl/PVC)	1 Year



\*Powder-coated Drains - Finishes available on request, but supplied **No Warranty**.

Powder-coated finishes are not suitable for drain installations. Oben recommends Stainless Steel finishes only which is covered by Oben's 15 year warranty. Refer to [www.oben.co.nz](http://www.oben.co.nz) for further warranty Terms & Conditions.

1

### 100% WATERPROOF

The high density **50kg/m<sup>3</sup>** closed cell cross linked XPS core is 100 % waterproof.

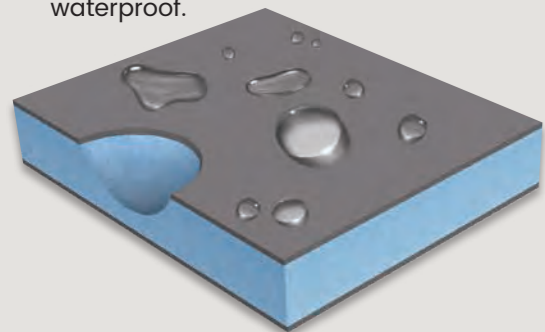

### POLYURETHANE ADHESIVE KIT



### CEMENTITIOUS ADHESIVE KIT



OR

4

### ADHESIVE KITS

Base Adhesive Kit included

2

### ROCK-SOLID CONSTRUCTION

The **polyceramic** surface forms an incredibly strong and stable base for ceramic tile adhesive.

- Polyceramic Layer
- Reinforcing mesh
- Cross-linked HD XPS Core
- Brick mesh
- Polymer Cement layer

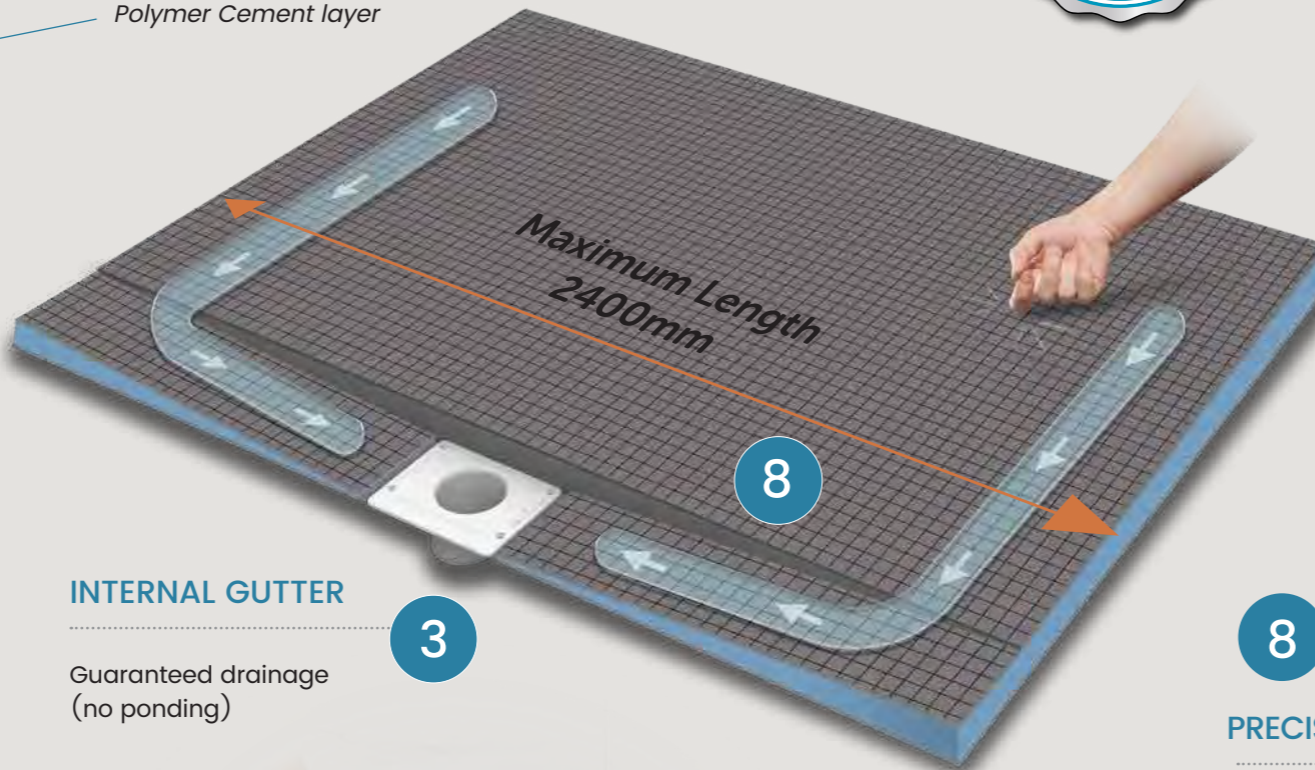
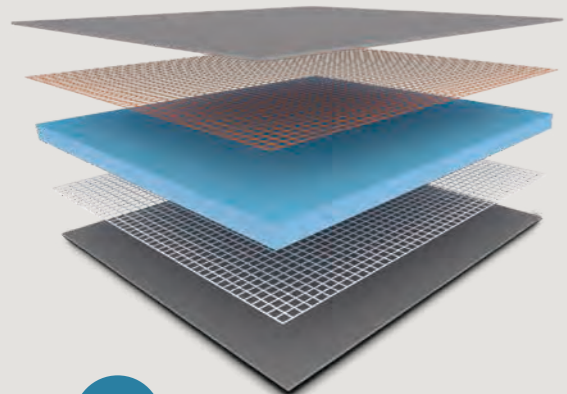

### INTERNAL GUTTER

Guaranteed drainage (no ponding)

3

5

### LOW HOB DESIGN

Ultra modern low profile. Only 50mm step in height or level entry design.



6

### 25 YEAR WARRANTY\*

The 25-year quality guarantee applies to the entire Rock-Stone® base range. Oben is setting new standards when it comes to quality leadership.

7

### “KNOCK - KNOCK”

Feel the difference  
The Rock-Solid feel of Oben Rock-Stone® base says it all.

8

### PRECISELY PRE-FABRICATED SLOPE

The perfectly faceted slope ensures optimum tiling. Pre-Formed slope guarantees surface drainage.



9

### PRODUCT RANGE

More options, more shapes! Sizes from 800 mm wide to 2400 mm long as well as Centre, Left, Right and Back drain outlet positions.

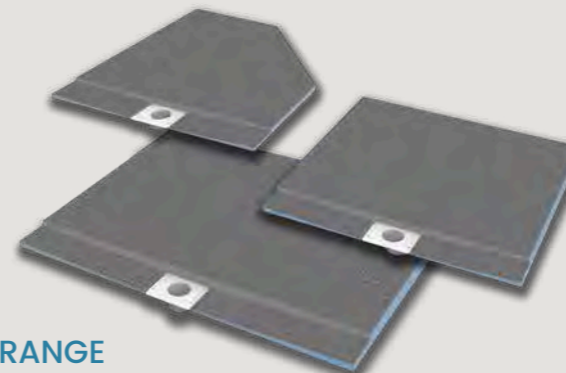

100% Waterproof



Save up to 50% on installation time



Guaranteed slope angle to drain

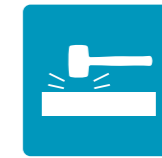

Superior strength and impact resistance



Easily installed



Suitable for all tile sizes

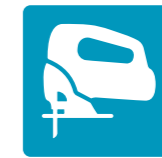

Easily cut



Superior thermal insulating qualities



Superior sound insulating qualities



Dimensionally stable

# Elusion® Channel Drains

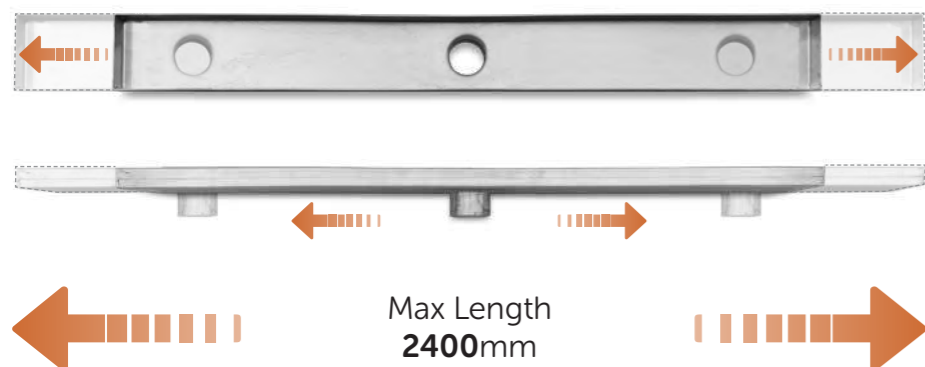
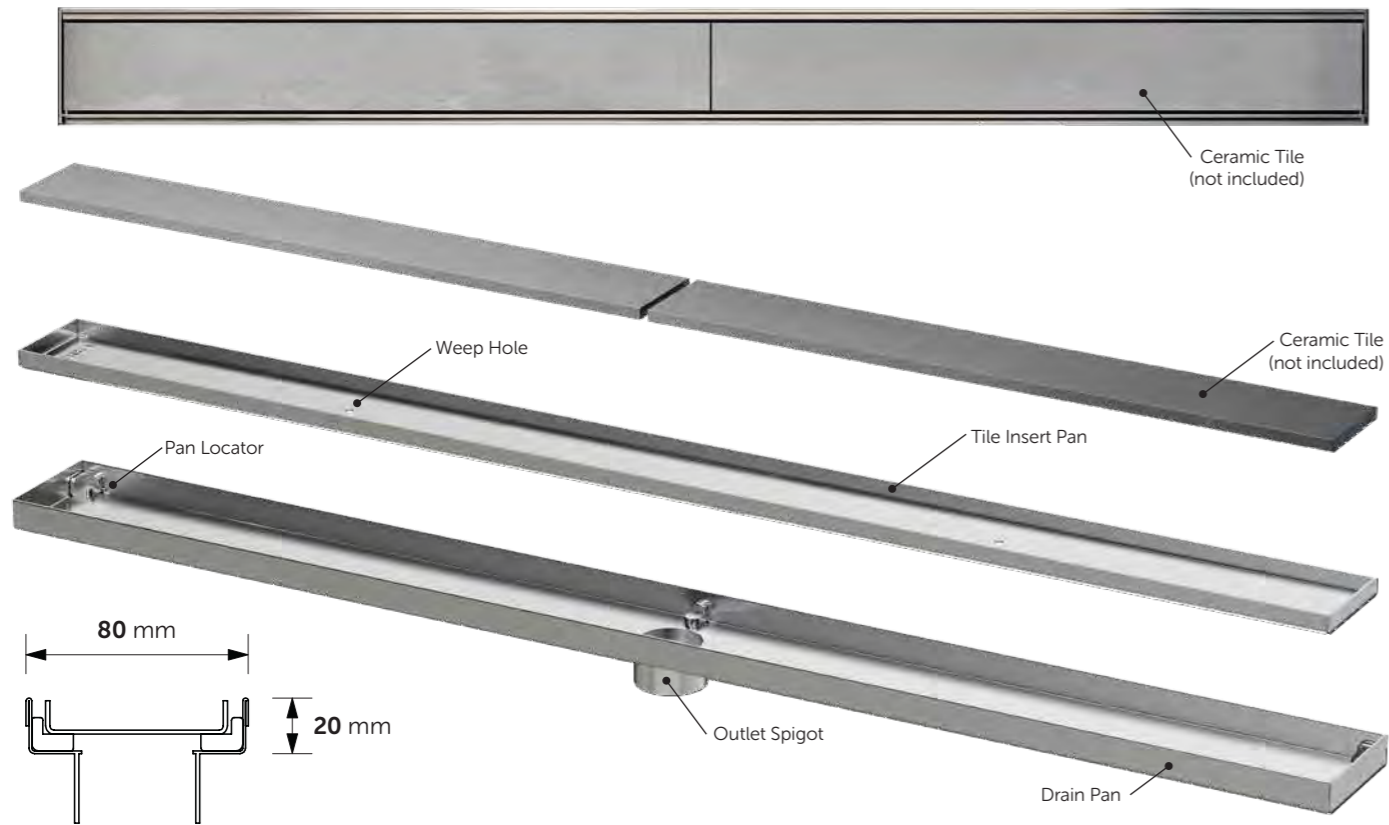

## CUSTOM DRAINS

- ✓ • Any Length
- ✓ • Any Drain position
- ✓ • Tiled Insert

NOTE: Custom drain length or outlet position made to order. Refer [www.oben.co.nz](http://www.oben.co.nz) for Custom Order Form

## ELUSION J GULLY HI FLOW TILE DRAIN

80 x 50

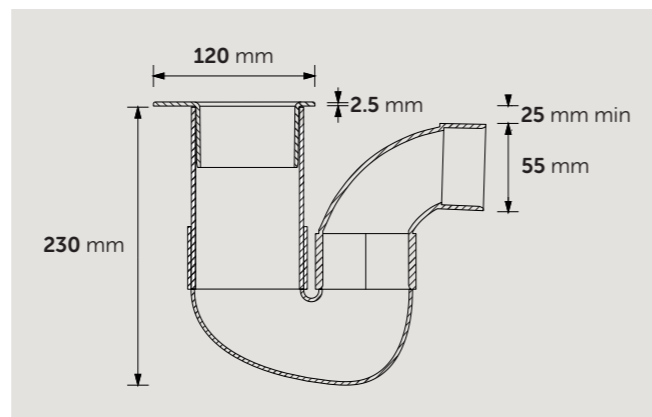

# Elusion® Channel Drain Installation

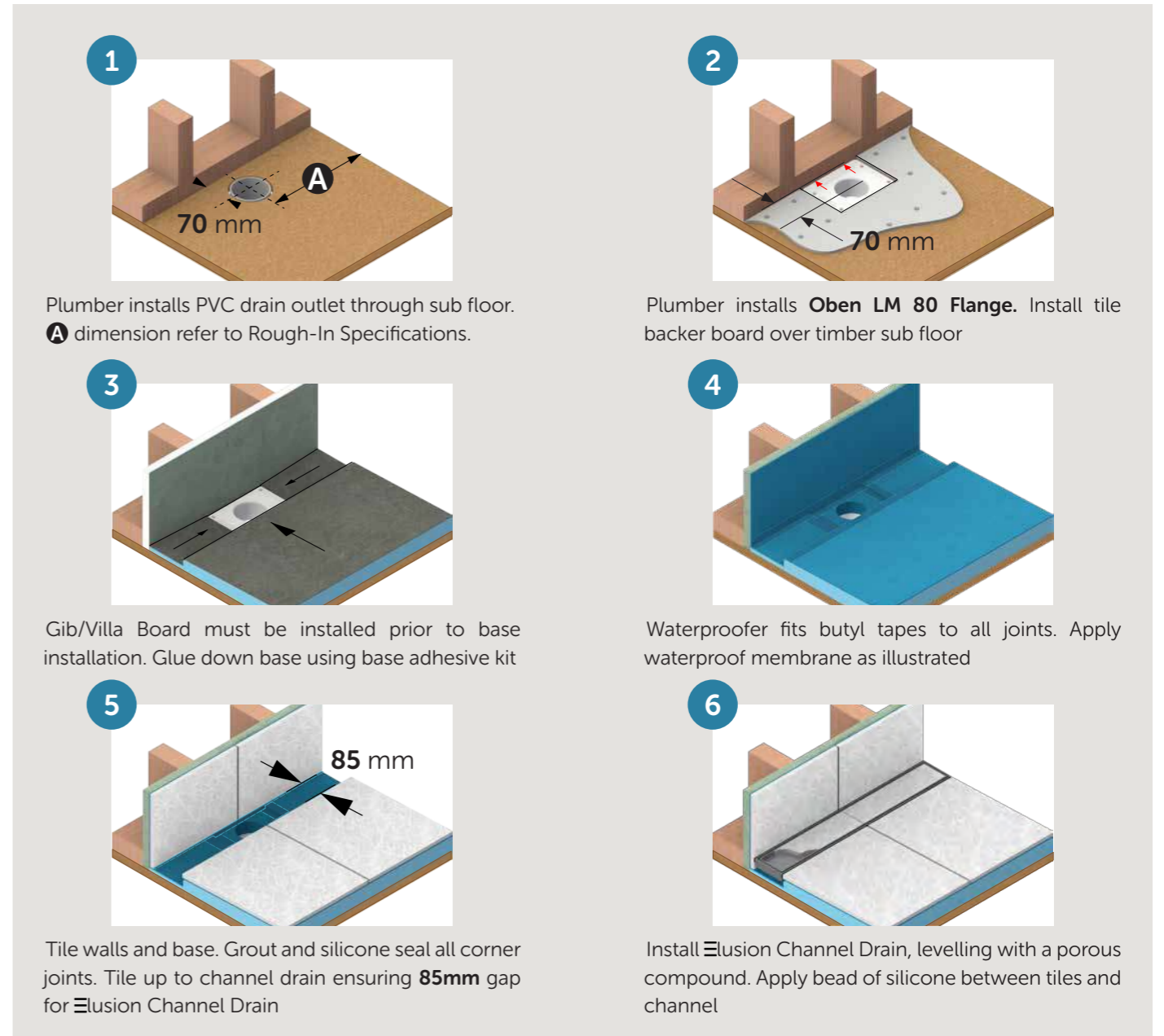

## TECHNICAL DETAILS

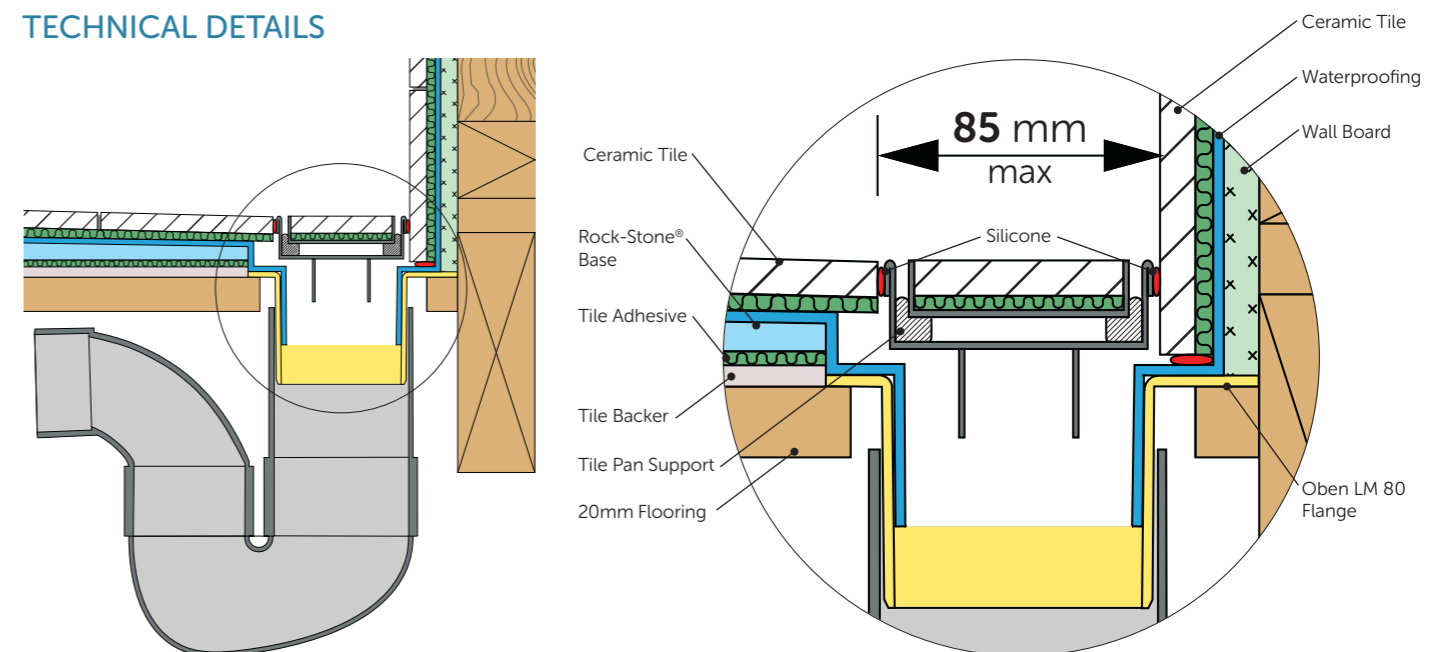



# Base installation easy as 1 2 3



## Polyurethane adhesive kit



### Floor Substrate

- ✓ Plywood
- ✓ Timber
- ✓ Tile & Slate underlay
- ✓ Composed fibre cement sheet

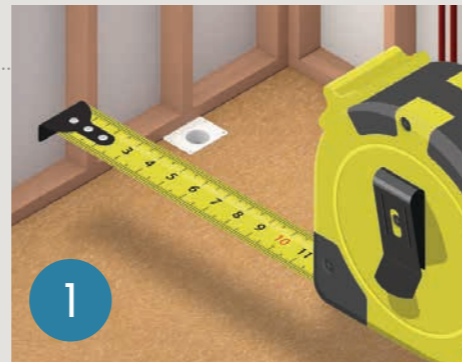

1 Measure / Dry fit base



2 Applying polyurethane adhesive

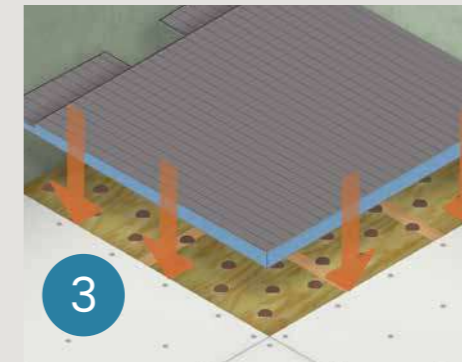

3 Installing base

## Cementitious adhesive kit



### Floor Substrate

- ✓ Concrete floor



1 Measure / Dry fit base

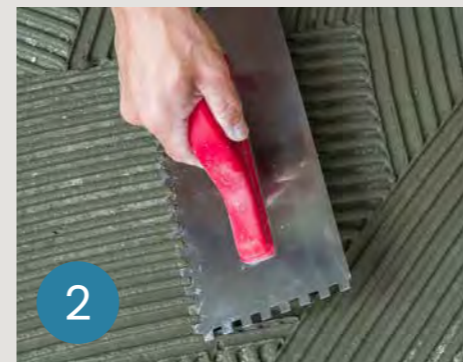

2 Apply cementitious adhesive

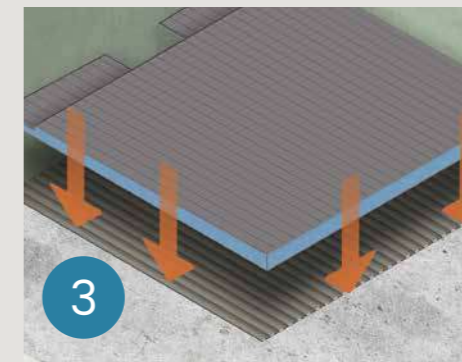

3 Installing base

## THE BEST GUARANTEE OF ALL

For over 95 years Oben's founders have set their own benchmark of excellence through innovative design, quality products and a passion for service that continues long after purchase.

All Oben products are made from the highest-quality materials and assembled only by trained craftsmen. Superior design and function are matched by a level of robustness and durability that is, ultimately, **the best guarantee** of all.



## A perfect fit every time

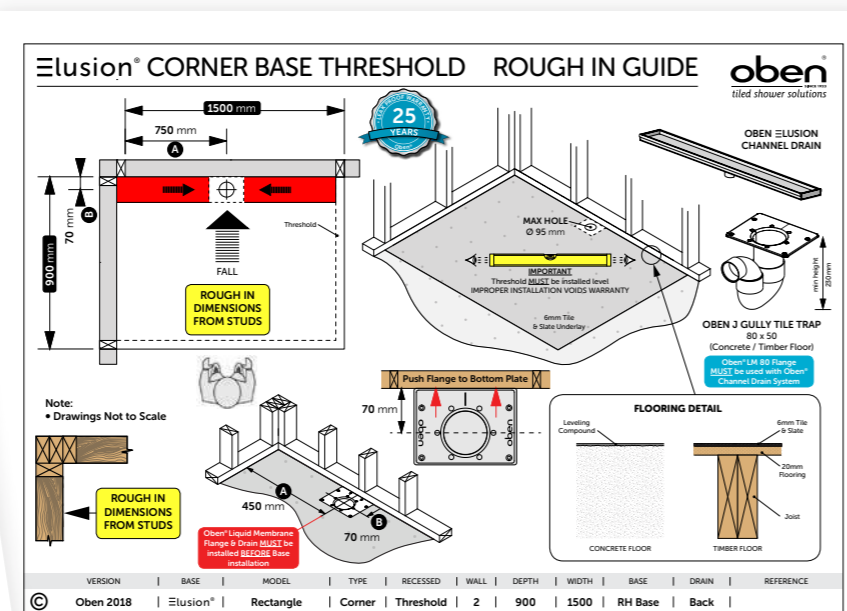
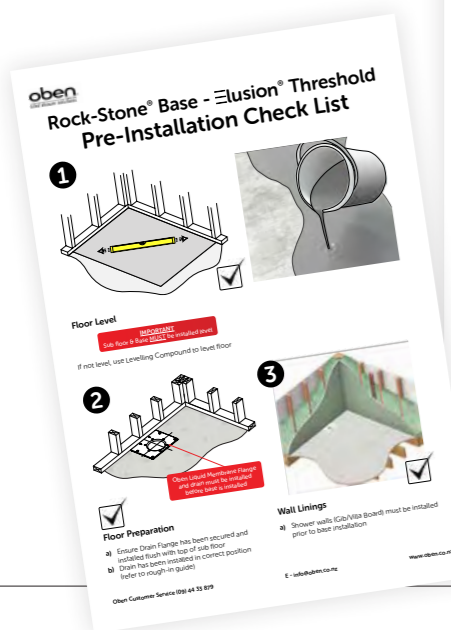

## Delivery Nationwide

- ✓ Rock-Stone® Base
- ✓ Rock-Stone® Niches
- ✓ PVC Shower Drains
- ✓ Channel Drains
- ✗ Excludes Frameless Glass showers (Auckland Region only)



CALL oben.

T: 09 44 33 879

E: sales@oben.co.nz

www.oben.co.nz

# Order custom size

# Custom design

Creating your custom size shower is easy with Oben

## Any shape Any size

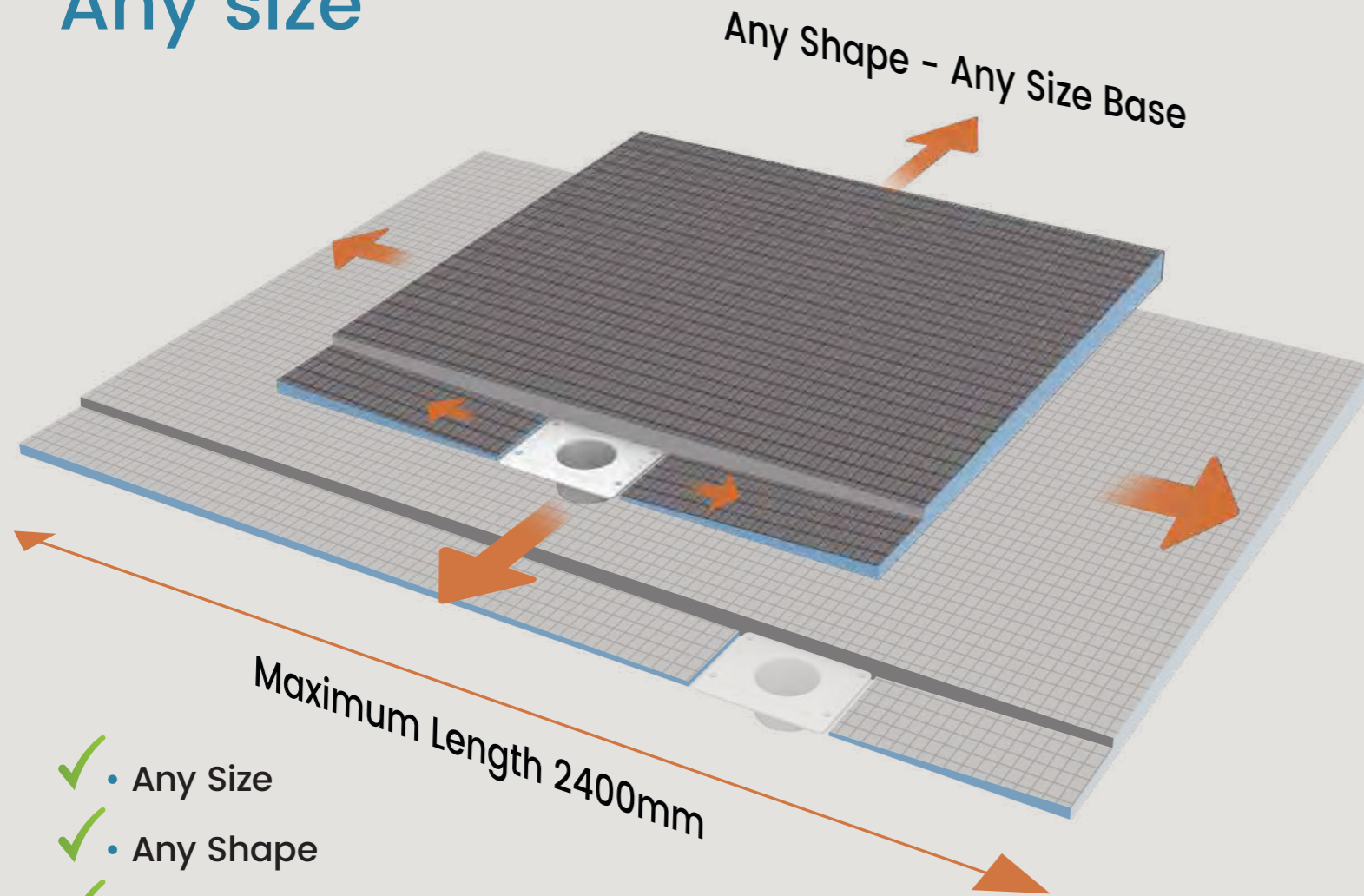

- ✓ • Any Size
- ✓ • Any Shape
- ✓ • Any Drain Location
- ✓ • Level Entry or Threshold

Rock-Stone® Bases are custom made to your exact dimensions ensuring

## A perfect fit every time

ORDERING  
YOUR CUSTOM  
SHOWER



DESIGN EXPERTISE KNOW HOW

## Send us your plans for a Free Quote



ORDER STEPS

- STEP 1 - Call / Email
- STEP 2 - Quote
- STEP 3 - Design
- STEP 4 - Deliver



1 Mark outline of base on timber floor.

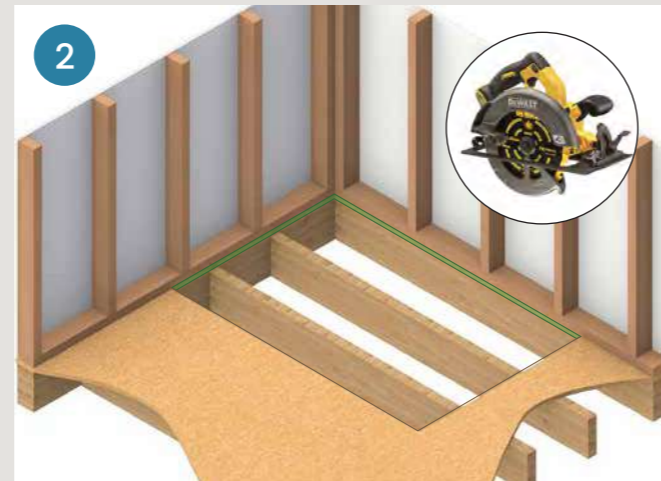

2 Cut out 20mm flooring and remove.

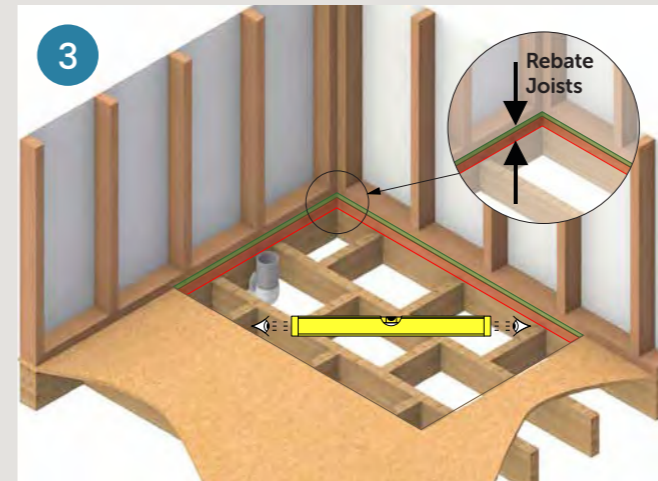

3 Rebate joists to required depth to suit base model  
Fix additional joists to support ply infill ([www.oben.co.nz](http://www.oben.co.nz))

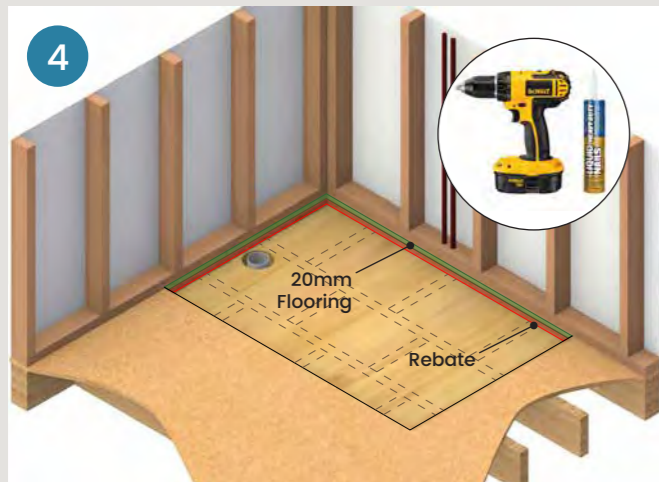

4 Install 20mm marine ply or compressed sheet.  
Glue and screw into position.

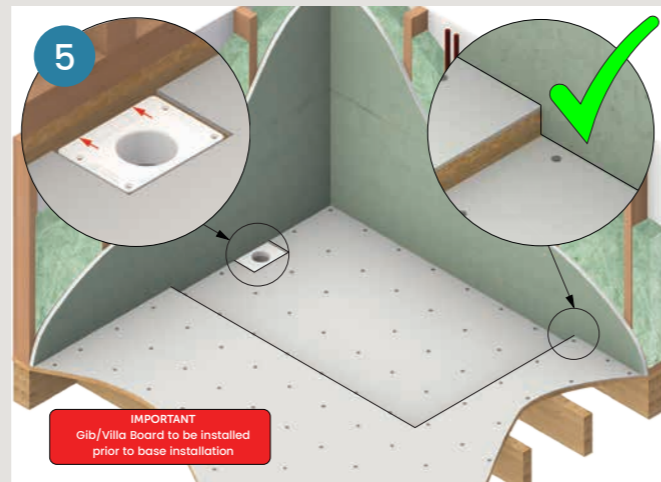

5 Glue PVC Flange to drain. Install tile & slate, ensuring 6mm clearance around LM flange. Install Gib/Villa board walls to bottom of rebate

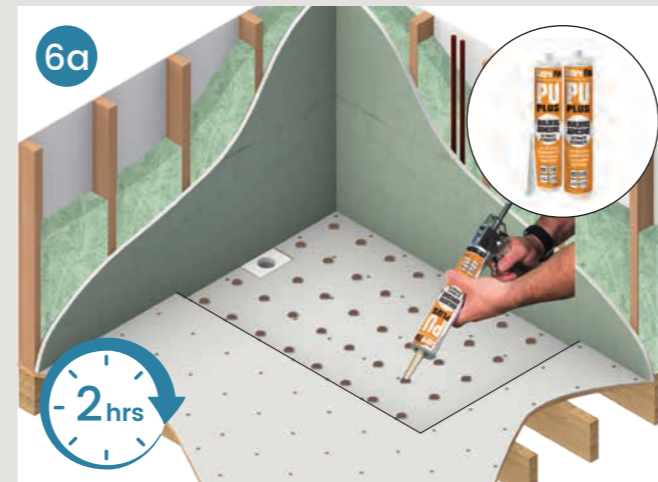

6a **Tile & Slate Floor** - Apply polyurethane adhesive.  
2hr cure time (adhesive kit included).

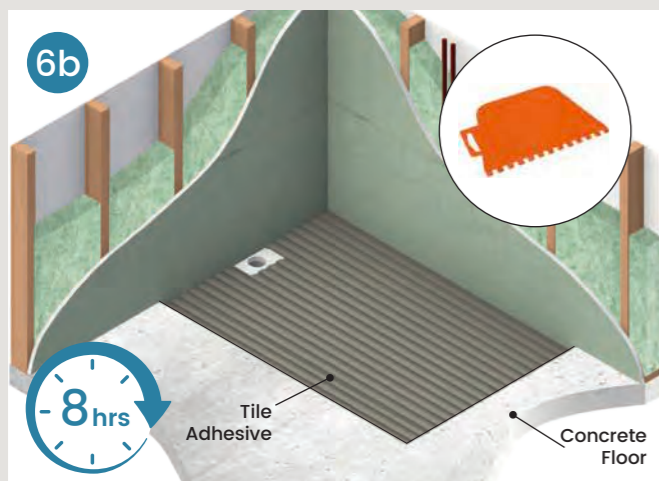

6b **Concrete Floor** - Mix tile adhesive and apply with trowel into rebated base area. 8 hour cure time (adhesive kit included).



7 **Install Elusion® base** and weigh down with adhesive pail filled with water.

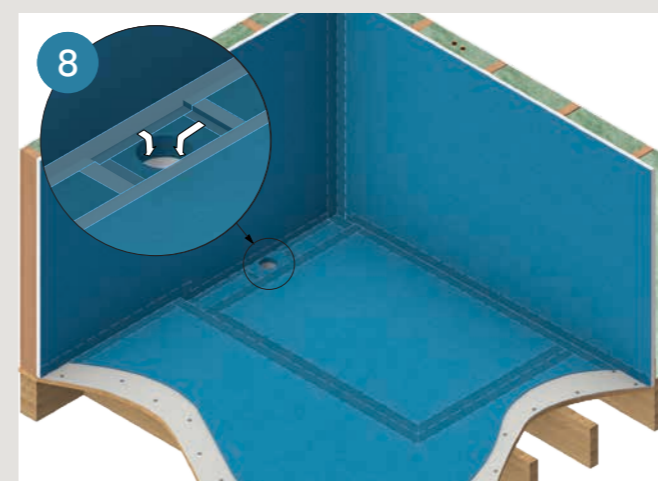

8 Apply butyl tapes and waterproof floors and walls.  
**Excludes waterproofing** - supplied by others

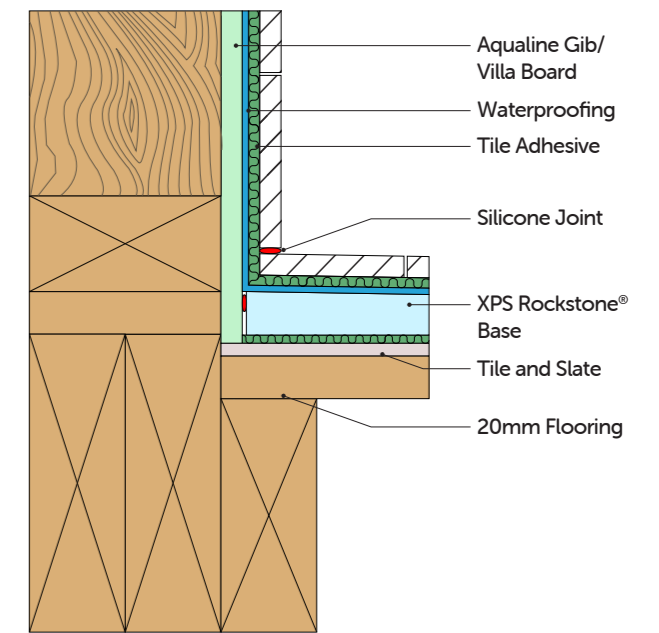

Wall detail

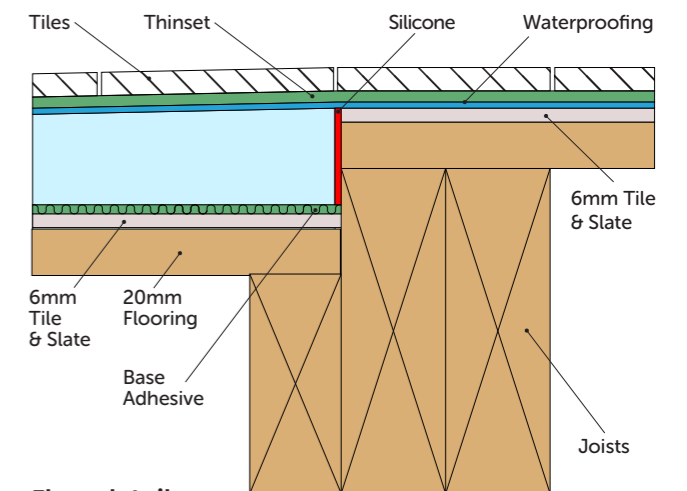

Floor detail

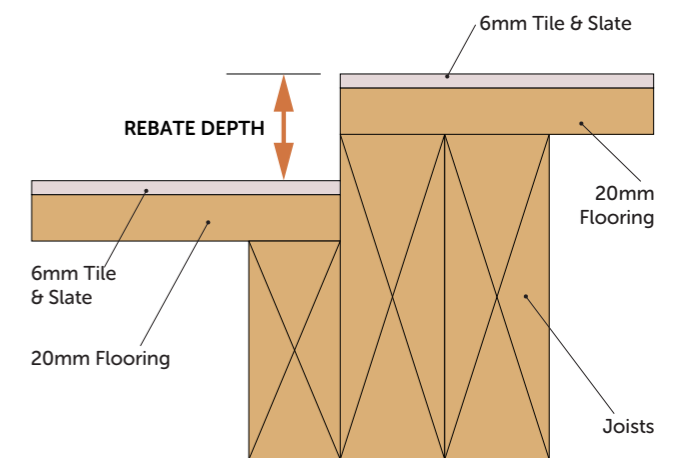

Rebate detail

# Elusion Rock-Stone® Base Level Entry

## ELUSION ALCOVE - RECTANGLE

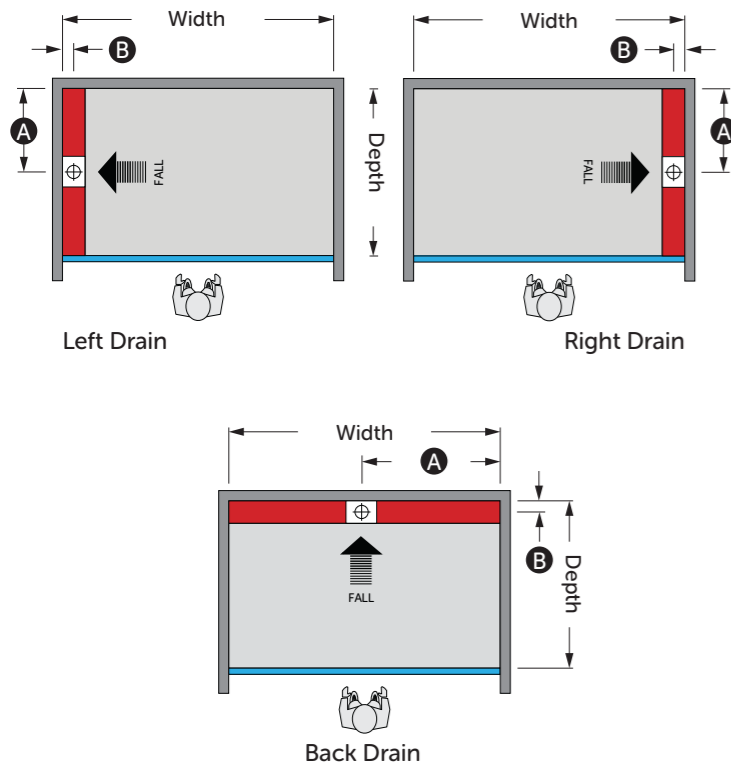

Size Depth X Width
900 X 1000
900 X 1100
900 X 1200
900 X 1300
900 X 1400
900 X 1500
900 X 1600
900 X 1700
900 X 1800
900 X 1900
900 X 2000

Drain Outlet		
LH / RH A	Back A	B
450	500	70
450	550	70
450	600	70
450	650	70
450	700	70
450	750	70
450	800	70
450	850	70
450	900	70
450	950	70
450	1000	70

Recess Depth	
LH / RH Drain	Back Drain
50	50
50	50
50	50
50	50
50	50
50	50
60	50
60	50
60	50
60	50
60	50

1000 X 1100
1000 X 1200
1000 X 1300
1000 X 1400
1000 X 1500
1000 X 1600
1000 X 1700
1000 X 1800
1000 X 1900
1000 X 2000

500	550	70
500	600	70
500	650	70
500	700	70
500	750	70
500	800	70
500	850	70
500	900	70
500	950	70
500	1000	70

50	50
50	50
50	50
50	50
50	50
60	50
60	50
60	50
60	50
60	50
60	50



## ELUSION ALCOVE - SQUARE

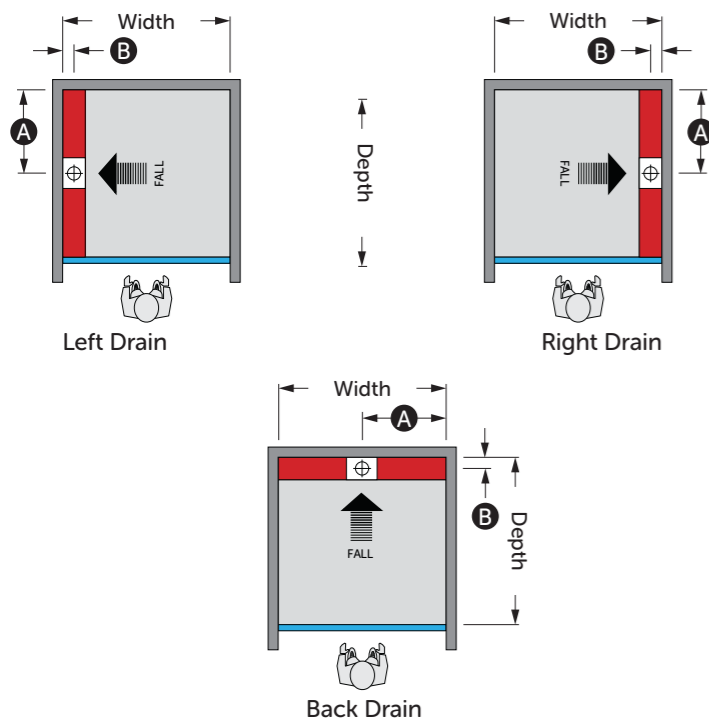

Size Depth X Width
900 X 900
950 X 950
1000 X 1000
1050 X 1050
1100 X 1100
1200 X 1200

Drain Outlet		
LH / RH A	Back A	B
450	450	70
475	475	70
500	500	70
525	525	70
550	550	70
600	600	70

Recess Depth	
LH / RH Drain	Back Drain
50	50
50	50
50	50
50	50
50	50
50	50

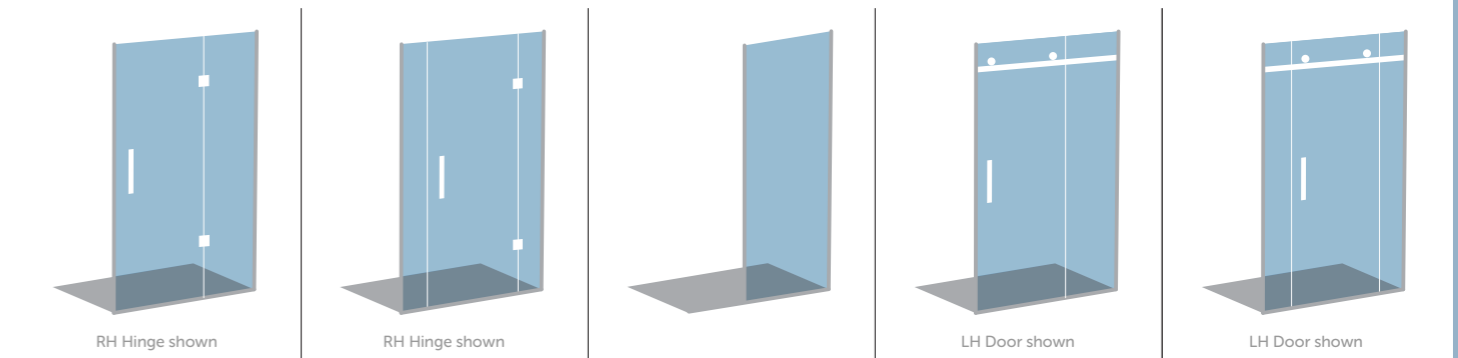

DOOR OFFSET (Reversible)	DOOR CENTRE (Reversible)	FIXED PANEL (Reversible)	2-P SLIDING (Reversible)	3-P SLIDING (Reversible)
●	●			
●	●			
●	●		●	
●	●		●	
●	●	●	●	
●	●	●	●	
●	●	●	●	●
●	●	●	●	●
●	●	●	●	●
●	●	●	●	●
●	●	●	●	●
●	●	●	●	●
●	●	●	●	●
●	●	●	●	●
●	●	●	●	●

●	●		●	
●	●		●	
●	●		●	
●	●	●	●	
●	●	●	●	
●	●	●	●	●
●	●	●	●	●
●	●	●	●	●
●	●	●	●	●
●	●	●	●	●
●	●	●	●	●
●	●	●	●	●
●	●	●	●	●
●	●	●	●	●
●	●	●	●	●

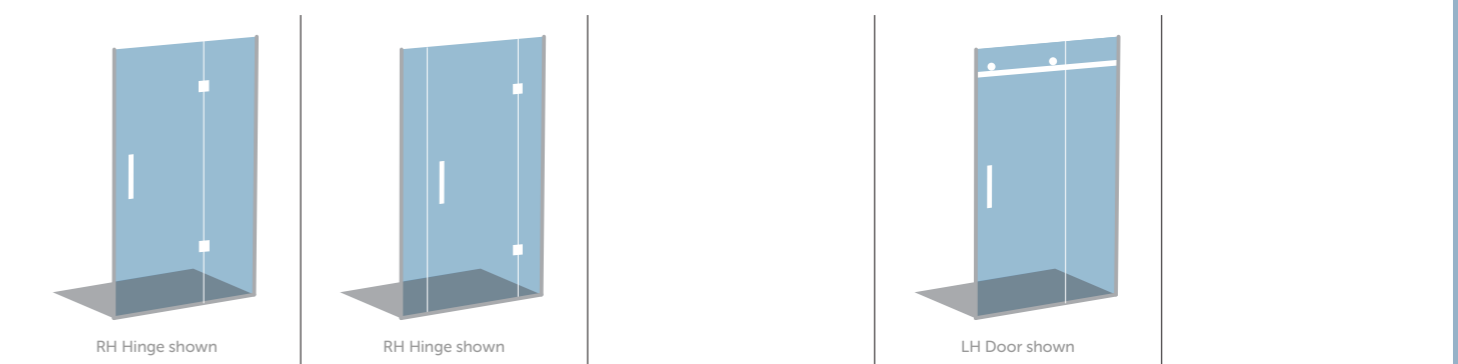

DOOR OFFSET (Reversible)	DOOR CENTRE (Reversible)		2-P SLIDING (Reversible)	
●	●			
●	●			
●	●			
●	●			
●	●			
●	●		●	
●	●			

# Elusion Rock-Stone® Base Level Entry

## ELUSION CORNER - RECTANGLE

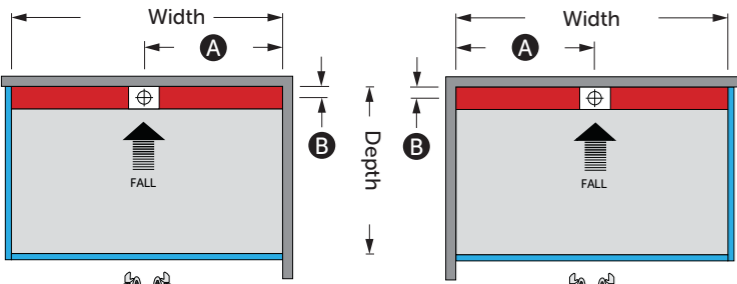

Left Hand Base Back Drain

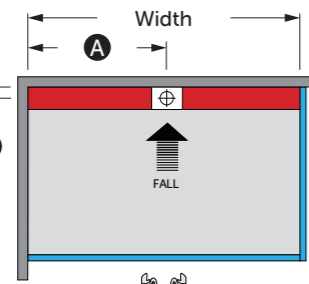

Right Hand Base Back Drain

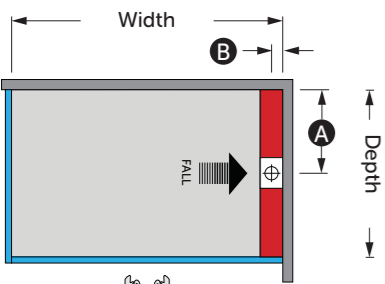

Left Hand Base Right Drain

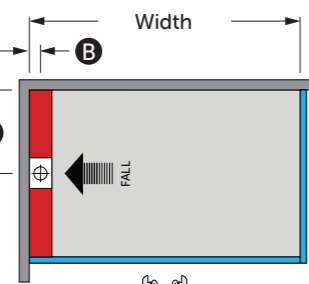

Right Hand Base Left Drain

Size Depth X Width	LH / RH A	Back A	B
900 X 1000	450	500	70
900 X 1100	450	550	70
900 X 1200	450	600	70
900 X 1300	450	650	70
900 X 1400	450	700	70
900 X 1500	450	750	70
900 X 1600	450	800	70
900 X 1700	450	850	70
900 X 1800	450	900	70
900 X 1900	450	950	70
900 X 2000	450	1000	70

Drain Outlet		
LH / RH A	Back A	B
450	500	70
450	550	70
450	600	70
450	650	70
450	700	70
450	750	70
450	800	70
450	850	70
450	900	70
450	950	70
450	1000	70

Recess Depth	
LH / RH Drain	Back Drain
50	50
50	50
50	50
50	50
50	50
50	50
60	50
60	50
60	50
60	50
60	50

1000 X 1100	500	550	70
1000 X 1200	500	600	70
1000 X 1300	500	650	70
1000 X 1400	500	700	70
1000 X 1500	500	750	70
1000 X 1600	500	800	70
1000 X 1700	500	850	70
1000 X 1800	500	900	70
1000 X 1900	500	950	70
1000 X 2000	500	1000	70

500	550	70
500	600	70
500	650	70
500	700	70
500	750	70
500	800	70
500	850	70
500	900	70
500	950	70
500	1000	70

50	50
50	50
50	50
50	50
50	50
50	50
60	50
60	50
60	50
60	50
60	50



## ELUSION CORNER - SQUARE

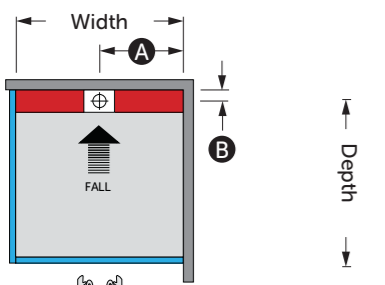

Left Hand Base Back Drain

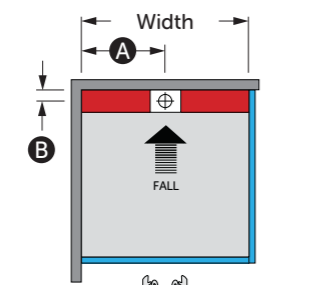

Right Hand Base Back Drain

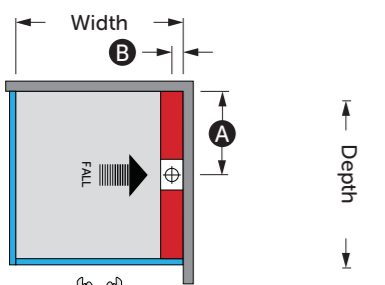

Left Hand Base Right Drain

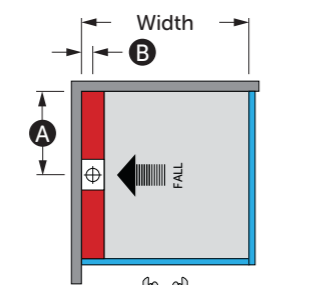

Right Hand Base Left Drain

Size Depth X Width	LH / RH A	Back A	B
900 X 900	450	450	70
950 X 950	475	475	70
1000 X 1000	500	500	70
1050 X 1050	525	525	70
1100 X 1100	550	550	70
1200 X 1200	600	600	70

Drain Outlet		
LH / RH A	Back A	B
450	450	70
475	475	70
500	500	70
525	525	70
550	550	70
600	600	70

Recess Depth	
LH / RH Drain	Back Drain
50	50
50	50
50	50
50	50
50	50
50	50

DOOR OFFSET (Reversible)	DOOR CENTRE (Reversible)	FIXED PANEL (Reversible)	WALK-IN (Reversible)	2-P SLIDING (Reversible)
RH Hinge shown				
RH Hinge shown				
LH Door shown				
LH Door shown				

DOOR OFFSET (Reversible)	DOOR CENTRE (Reversible)	FIXED PANEL (Reversible)	2-P SLIDING (Reversible)
RH Hinge shown			
RH Hinge shown			
LH Door shown			
LH Door shown			

# Elusion Rock-Stone® Base Level Entry

## ELUSION CORNER - J-WALK

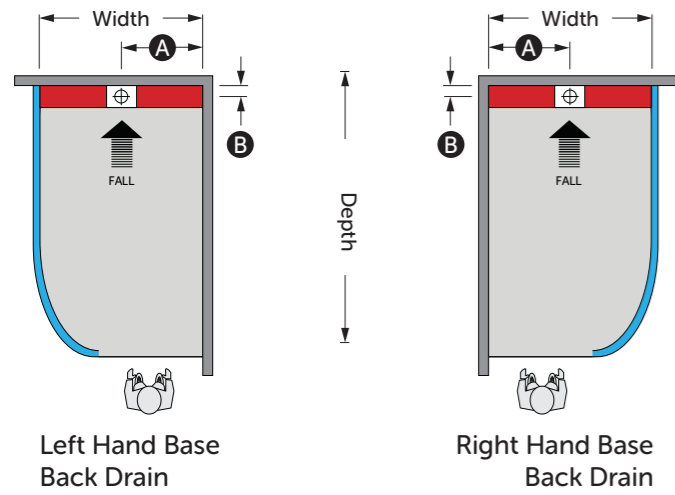

Size Width X Depth	Drain Outlet		Recess Depth
	Back A	B	
900 X 1250	450	70	50
1000 X 1250	500	70	50

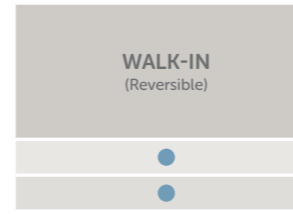
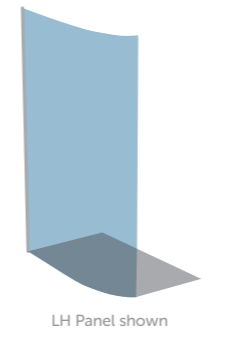

## ELUSION CORNER - NEO-ANGLE

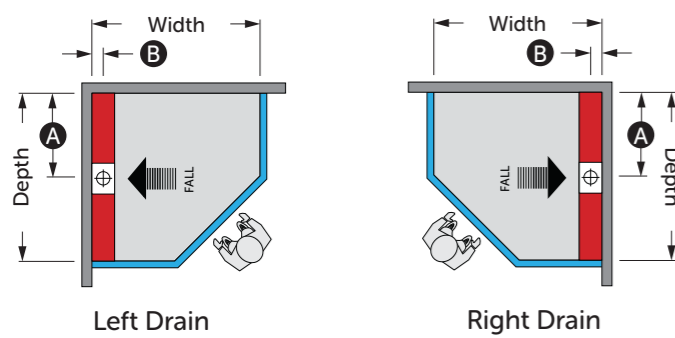

Size Depth X Width	Drain Outlet		Recess Depth
	LH / RH A	B	
900 X 900	450	70	50
950 X 950	475	70	50
1000 X 1000	500	70	50

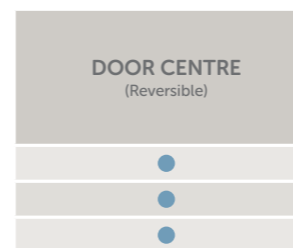
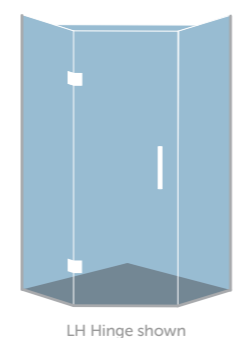

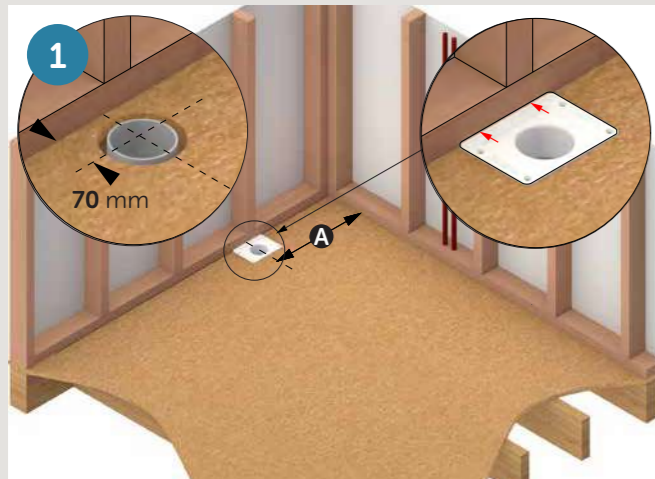

1 Install Oben LM 80 Flange, ensuring edge is butted up to bottom plate **A** dimension refer Technical Pages

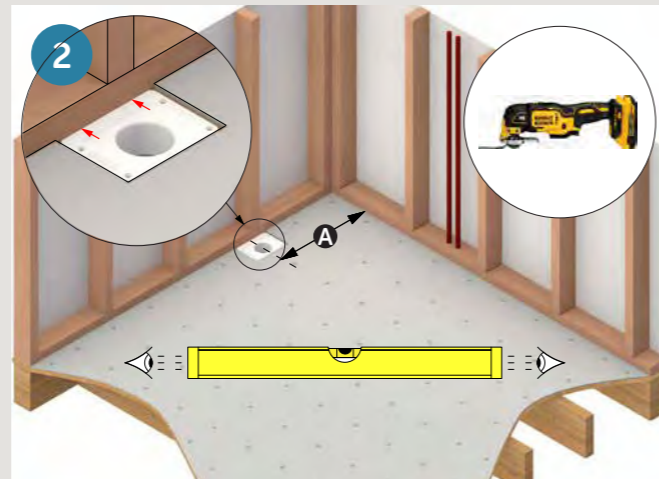

2 Lay 6mm Tile Backer board over floor, cut out rebate around LM 80 flange. Floor must be level

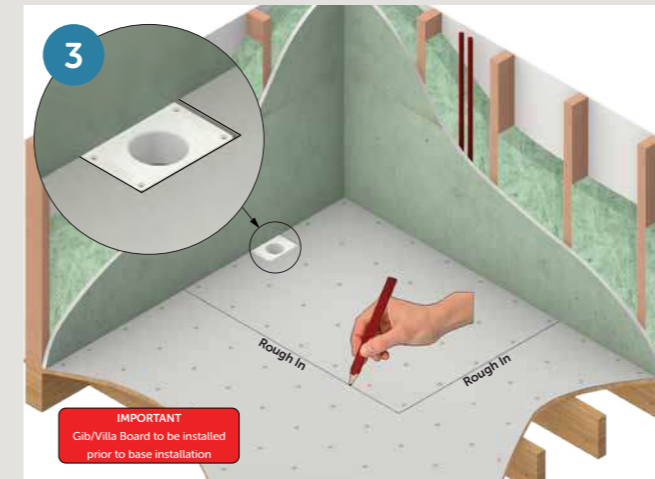

3 Install Gib/Villa Board walls ensuring wall board is installed to floor substrate. Dry fit base and mark outline on floor

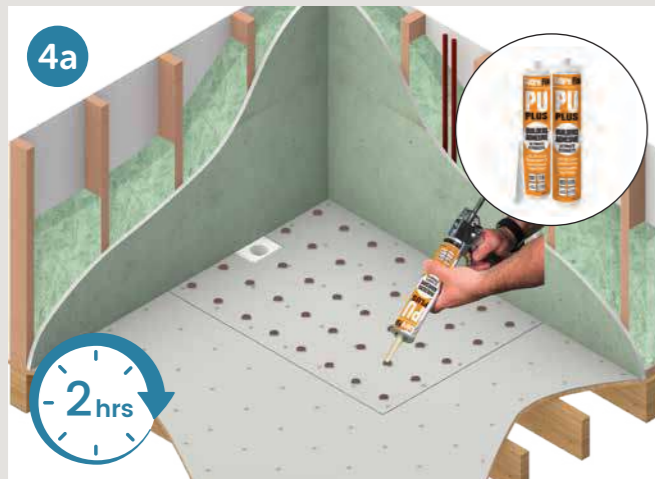

4a **Tile and Slate Floor** - Apply polyurethane adhesive. 2 hour cure time (Adhesive Kit included)

OR

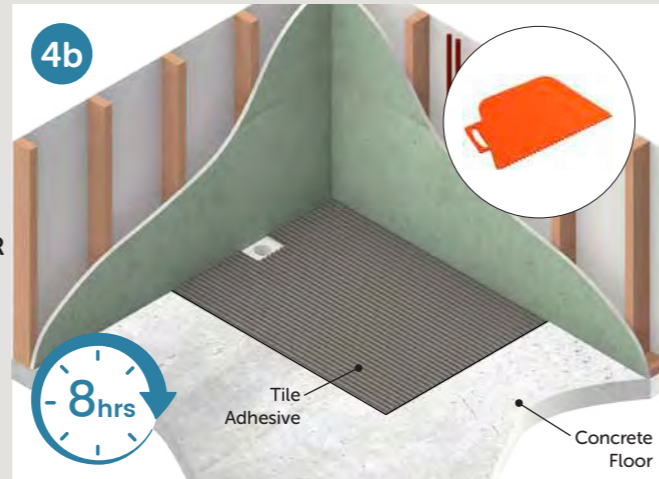

4b **Concrete Floor** - Mix tile adhesive kit and apply with trowel to outlined base area. 8 hour cure time (Adhesive Kit included)

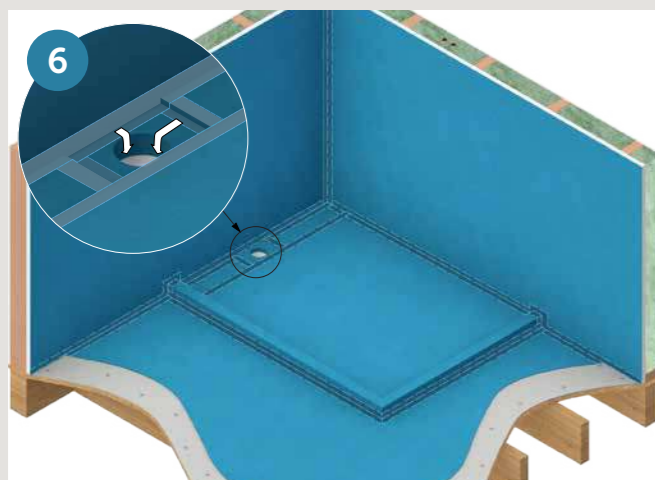

6 Apply butyl tapes, waterproof floor and walls as shown. Excludes waterproofing supplied by others.

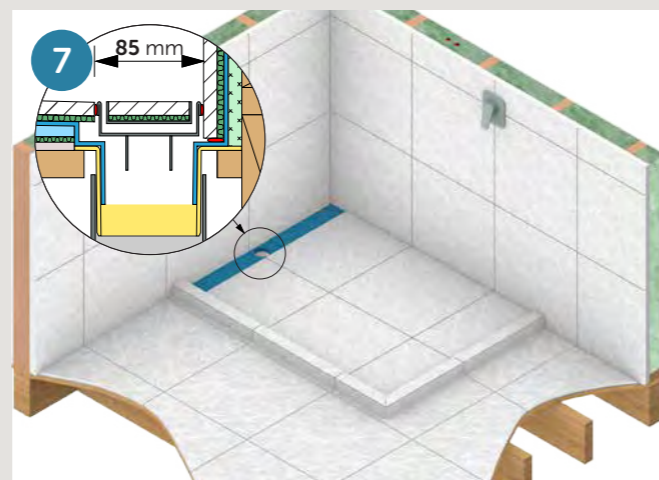

7 Tile walls and base. Grout and silicone seal all corner joints. **IMPORTANT** (Refer to Elusion channel drain Width & Length specifications)

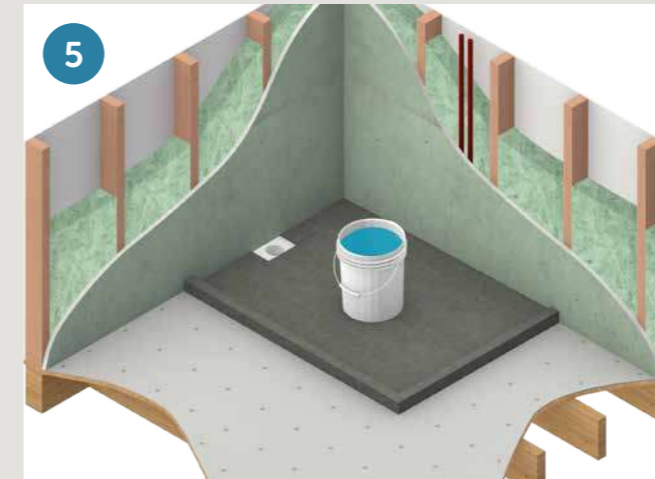

5 Install Elusion base and weigh down with adhesive pale filled with water or box of ceramic tiles



8 Fit Oben Elusion channel drain, tile insert inner pan and silicone into position.

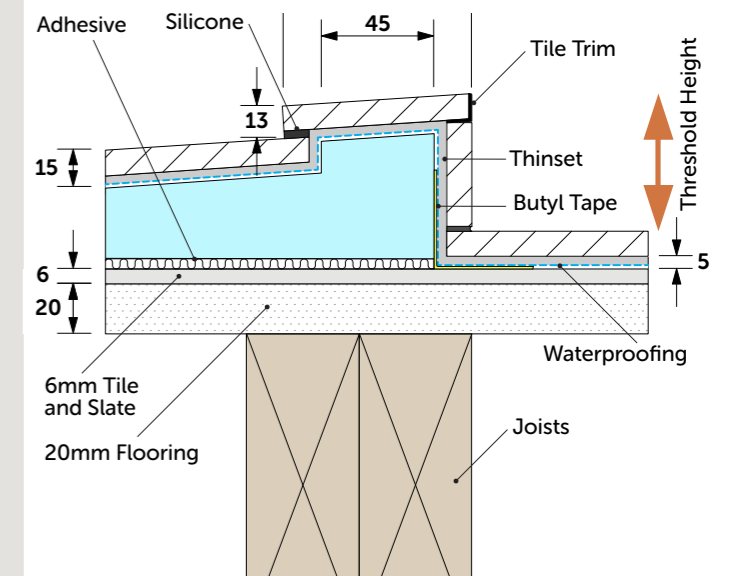

Ultra Low Threshold

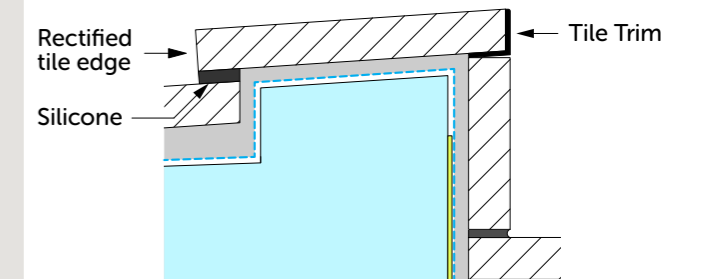

Tile Trim Edge

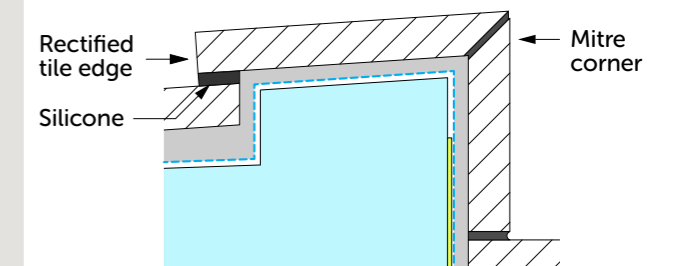

Mitred Edge

A tile that has been "rectified" has had all edges mechanically ground to achieve a smooth face. This process involves cutting and grinding the tile to a precise size.

# Elusion Rock-Stone® Base Threshold

## ELUSION ALCOVE - RECTANGLE

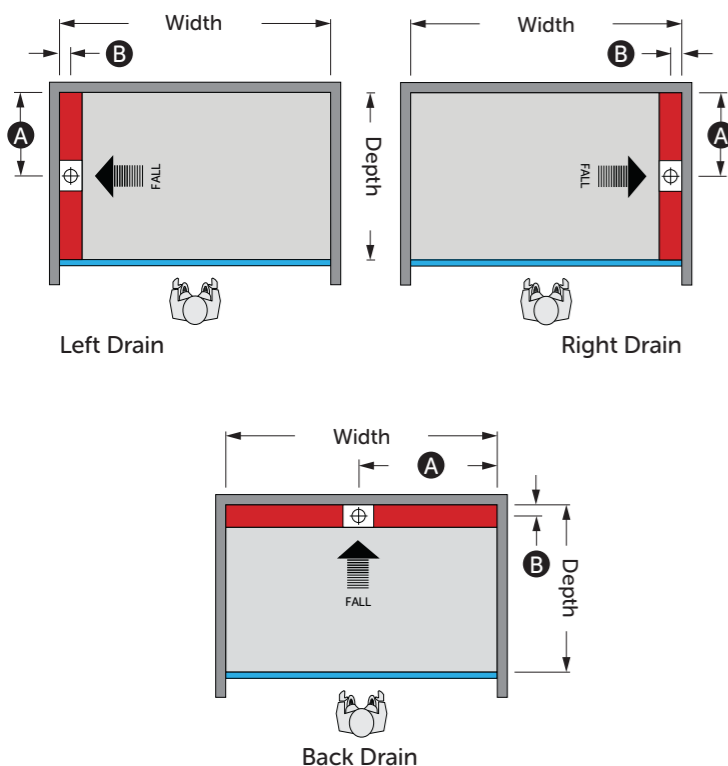

Size Depth X Width	Drain Outlet LH / RH A	Back A	B
900 X 1000	432	500	70
900 X 1100	432	550	70
900 X 1200	432	600	70
900 X 1300	432	650	70
900 X 1400	432	700	70
900 X 1500	432	750	70
900 X 1600	432	800	70
900 X 1700	432	850	70
900 X 1800	432	900	70
900 X 1900	432	950	70
900 X 2000	432	1000	70

1000 X 1100	482	550	70
1000 X 1200	482	600	70
1000 X 1300	482	650	70
1000 X 1400	482	700	70
1000 X 1500	482	750	70
1000 X 1600	482	800	70
1000 X 1700	482	850	70
1000 X 1800	482	900	70
1000 X 1900	482	950	70
1000 X 2000	482	1000	70

Drain Outlet		
LH / RH A	Back A	B
432	500	70
432	550	70
432	600	70
432	650	70
432	700	70
432	750	70
432	800	70
432	850	70
432	900	70
432	950	70
432	1000	70



Threshold Height	
LH / RH Drain	Back Drain
70	70
70	70
70	70
70	70
70	70
70	70
80	70
80	70
80	70
80	70
80	70
80	70
80	70
80	70
80	70
80	70

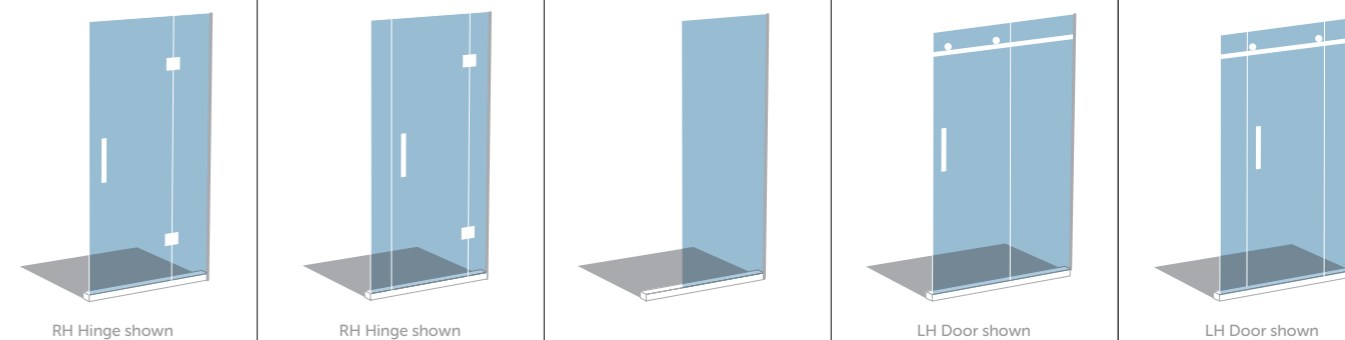

DOOR OFFSET (Reversible)	DOOR CENTRE (Reversible)	FIXED PANEL (Reversible)	2-P SLIDING (Reversible)	3-P SLIDING (Reversible)
●	●			
●	●			
●	●		●	
●	●		●	
●	●	●	●	
●	●	●	●	
●	●	●	●	●
●	●	●	●	●
●	●	●	●	●
●	●	●	●	●
●	●	●	●	●
●	●	●	●	●
●	●	●	●	●
●	●	●	●	●
●	●	●	●	●
●	●	●	●	●

## ELUSION ALCOVE - SQUARE

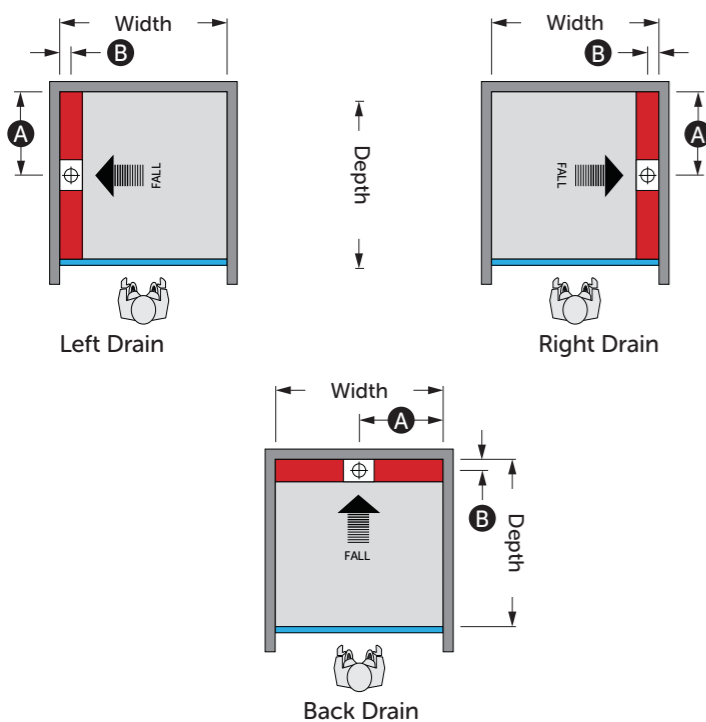

Size Depth X Width	Drain Outlet LH / RH A	Back A	B
900 X 900	432	450	70
950 X 950	458	475	70
1000 X 1000	482	500	70
1050 X 1050	508	525	70
1100 X 1100	532	550	70
1200 X 1200	582	600	70

Drain Outlet		
LH / RH A	Back A	B
432	450	70
458	475	70
482	500	70
508	525	70
532	550	70
582	600	70



Threshold Height	
LH / RH Drain	Back Drain
70	70
70	70
70	70
70	70
70	70
70	70

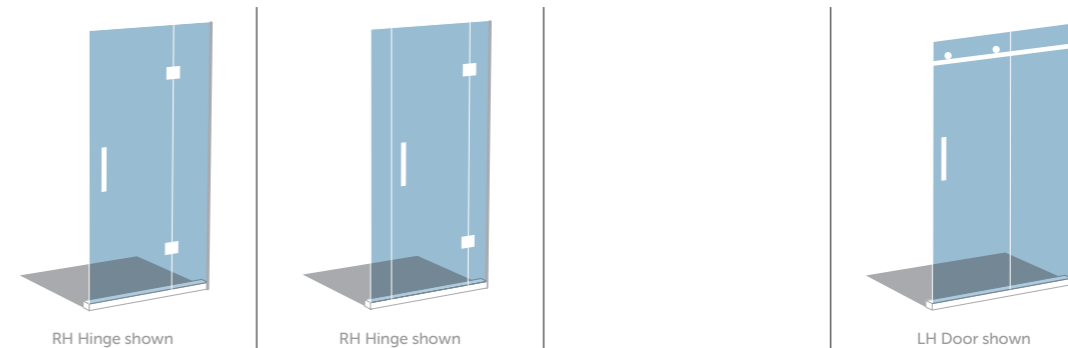

DOOR OFFSET (Reversible)	DOOR CENTRE (Reversible)	FIXED PANEL (Reversible)	2-P SLIDING (Reversible)	3-P SLIDING (Reversible)
●	●			
●	●			
●	●			
●	●			
●	●			
●	●		●	
●	●			



# Elusion Rock-Stone® Base Threshold

## ELUSION CORNER - RECTANGLE

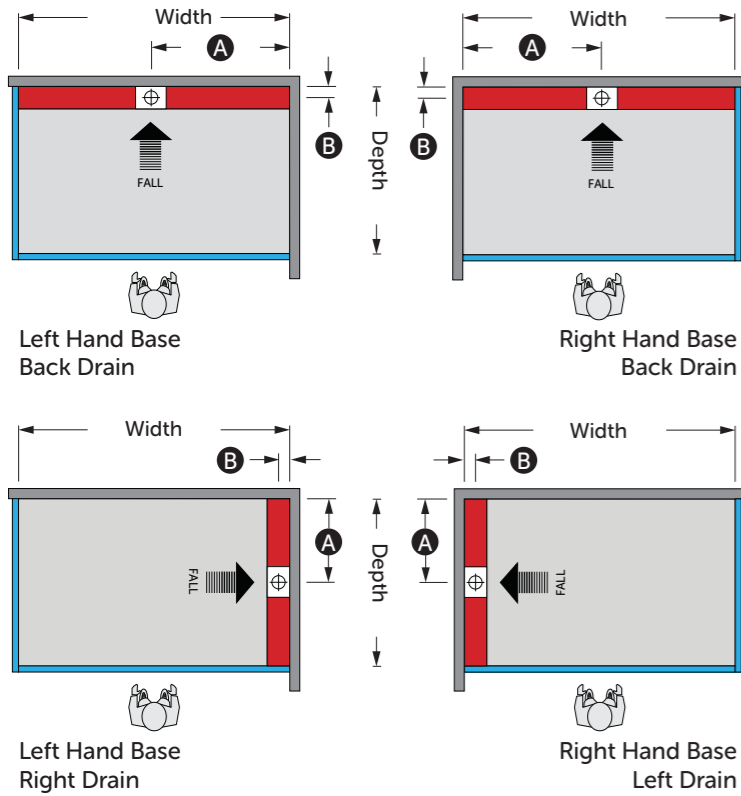

Size Depth X Width	LH / RH A	Back A	B
900 X 1000	432	500	70
900 X 1100	432	550	70
900 X 1200	432	600	70
900 X 1300	432	650	70
900 X 1400	432	700	70
900 X 1500	432	750	70
900 X 1600	432	800	70
900 X 1700	432	850	70
900 X 1800	432	900	70
900 X 1900	432	950	70
900 X 2000	432	1000	70

Drain Outlet		
LH / RH A	Back A	B
432	500	70
432	550	70
432	600	70
432	650	70
432	700	70
432	750	70
432	800	70
432	850	70
432	900	70
432	950	70
432	1000	70

Threshold Height	
LH / RH Drain	Back Drain
70	70
70	70
70	70
70	70
70	70
70	70
80	70
80	70
80	70
80	70
80	70



## ELUSION CORNER - SQUARE

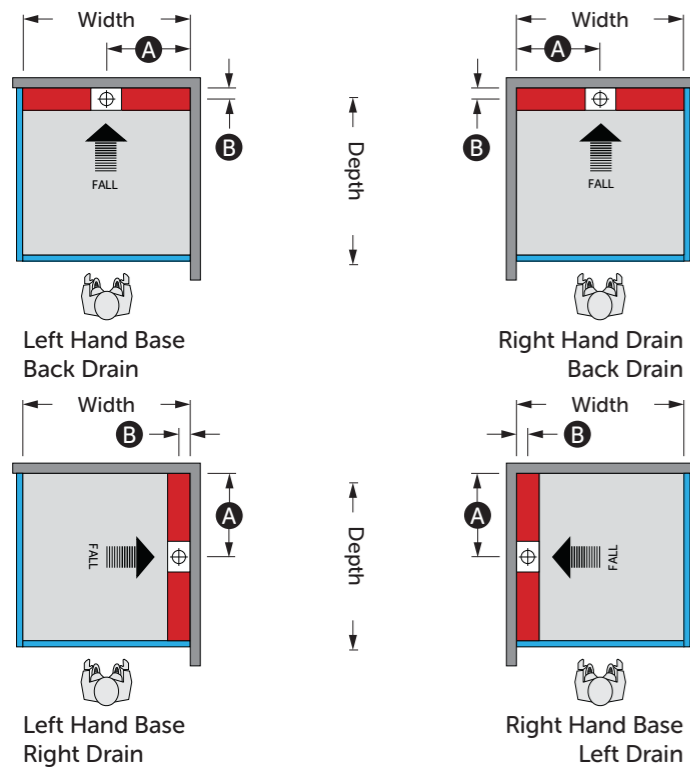

Size Depth X Width	LH / RH A	Back A	B
900 X 900	432	450	70
950 X 950	458	475	70
1000 X 1000	482	500	70
1050 X 1050	508	525	70
1100 X 1100	532	550	70
1200 X 1200	582	600	70

Drain Outlet		
LH / RH A	Back A	B
432	450	70
458	475	70
482	500	70
508	525	70
532	550	70
582	600	70

Threshold Height	
LH / RH Drain	Back Drain
70	70
70	70
70	70
70	70
70	70
70	70

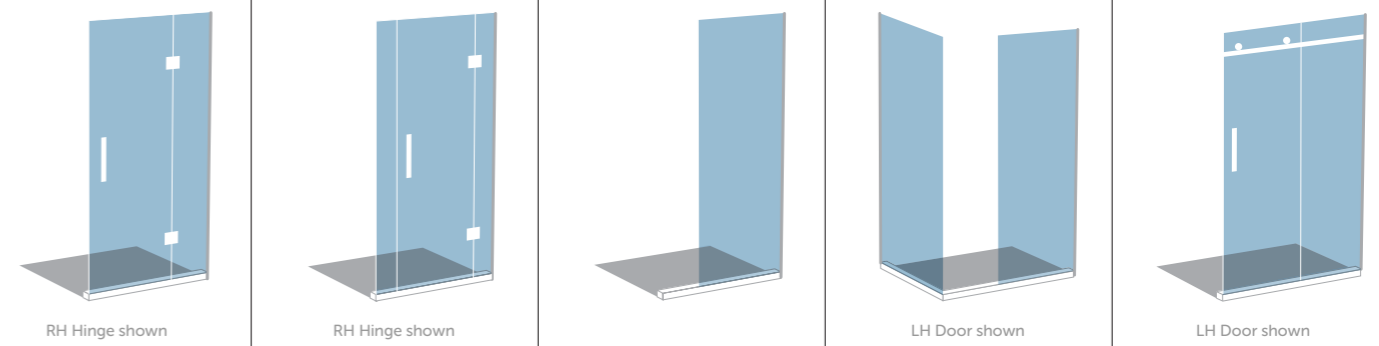

DOOR OFFSET (Reversible)	DOOR CENTRE (Reversible)	FIXED PANEL (Reversible)	WALK-IN (Reversible)	2-P SLIDING (Reversible)
●	●	●		
●	●	●		
●	●	●		●
●	●	●		●
●	●	●	●	●
●	●	●	●	●
●	●	●	●	●
●	●	●	●	●
●	●	●	●	●
●	●	●	●	●
●	●	●	●	●

●	●	●		
●	●	●		
●	●	●		●
●	●	●		●
●	●	●	●	●
●	●	●	●	●
●	●	●	●	●
●	●	●	●	●
●	●	●	●	●
●	●	●	●	●
●	●	●	●	●
●	●	●	●	●

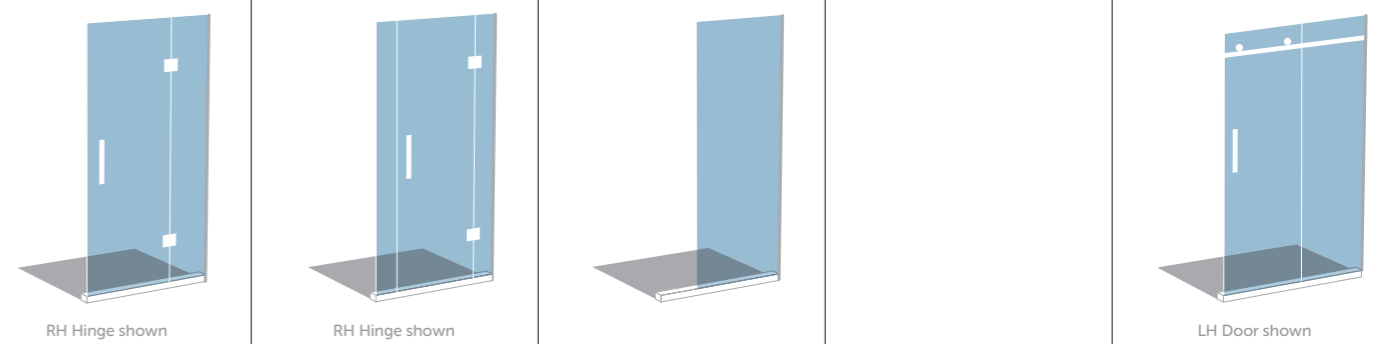

DOOR OFFSET (Reversible)	DOOR CENTRE (Reversible)	FIXED PANEL (Reversible)	2-P SLIDING (Reversible)	
●	●	●		
●	●	●		
●	●	●		
●	●	●		
●	●	●		
●	●	●		●

# Elusion Rock-Stone® Base Threshold

## ELUSION CORNER - NEO-ANGLE

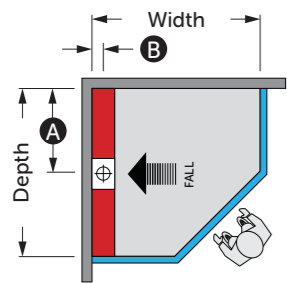

Left Drain

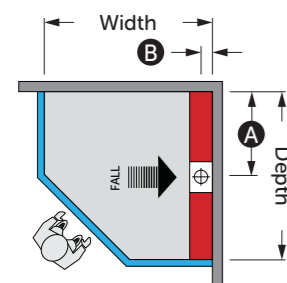

Right Drain

Size Depth X Width
900 X 900
950 X 950
1000 X 1000

Drain Outlet	
LH / RH	A
	432
	458
	482



Threshold Height	
LH / RH	Drain
	70
	70
	70

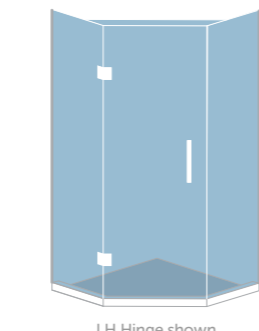

DOOR CENTRE (Reversible)	
	<input type="checkbox"/>
	<input type="checkbox"/>
	<input type="checkbox"/>

## WATER DEFLECTOR

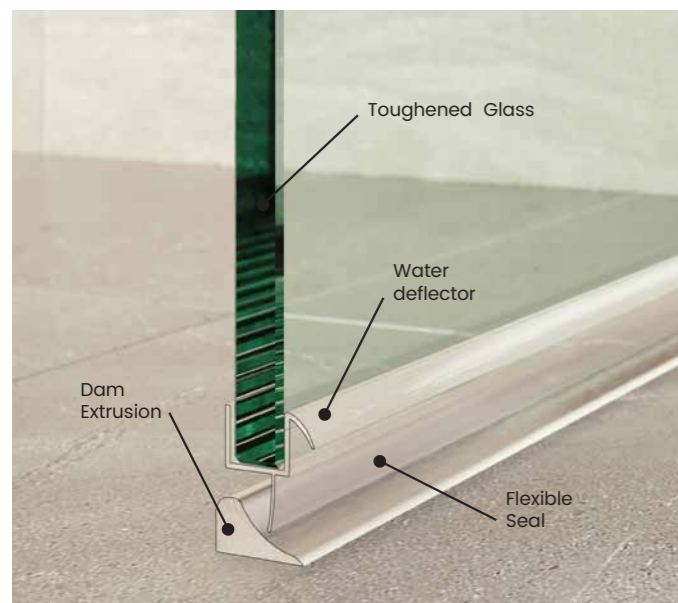

Low profile Dam and flexible seal deflect water back into shower

## GLASS ADJUSTMENT

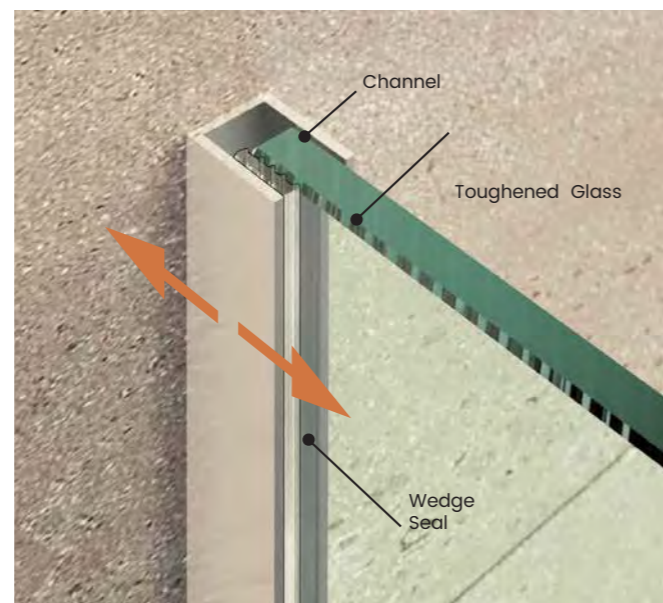

Channel allows glass adjustment for out of square walls (+/- 8 mm)

**STEP 1** Select Drain Length Drain Length specified in box will be length supplied

Channel Depth - 20mm  
Max Drain Length - 2000mm  
Centre Outlet - STANDARD

**STEP 2** Select Required Drain Position

Left Hand Outlet      Centre Outlet      Right Hand Outlet

Note: Standard drain position supplied in centre outlet unless specified

**STEP 3** If Offset Drain Required Please tick

Note: Measurement to be taken from outside edge of the channel to the centre of the outlet  
Offset (min 30mm max 50mm)

**STEP 4** Select Drain Finish Please tick

Stainless Steel       Black      Only available as Tile Insert Model

**Made to Order Drains are Non-Returnable**

Customer Name: ..... Date: .....

Customer Ph. Number: .....

Customer Ref Number: ..... Customer Signature: .....

# Recessed Tile Niches – Rough in

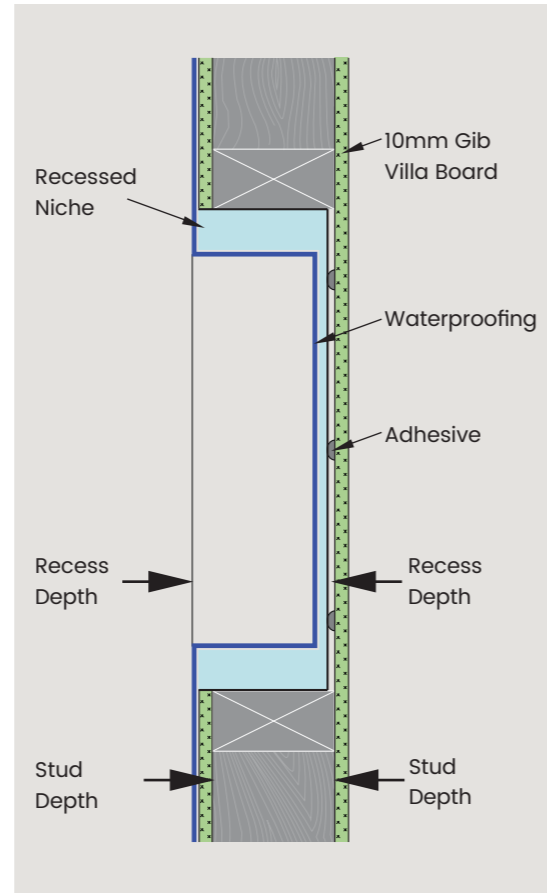
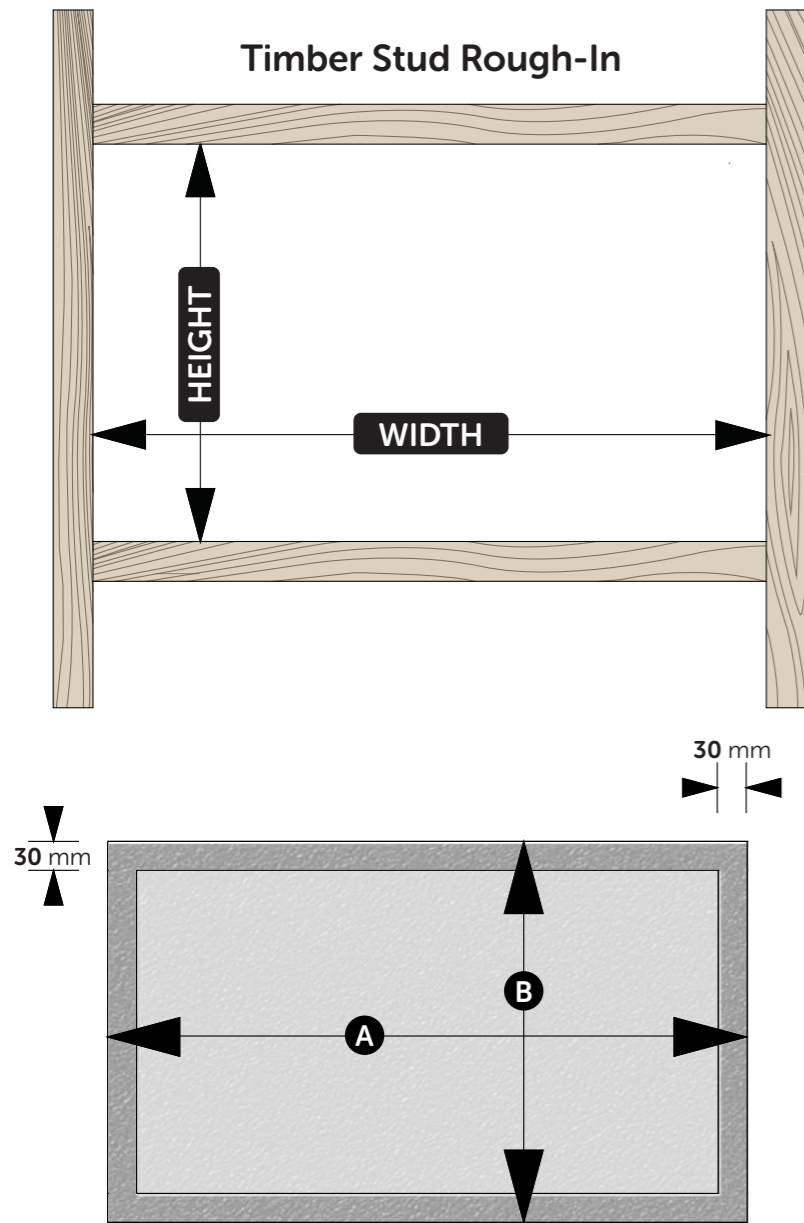

# Recessed Tile Niches – Installation

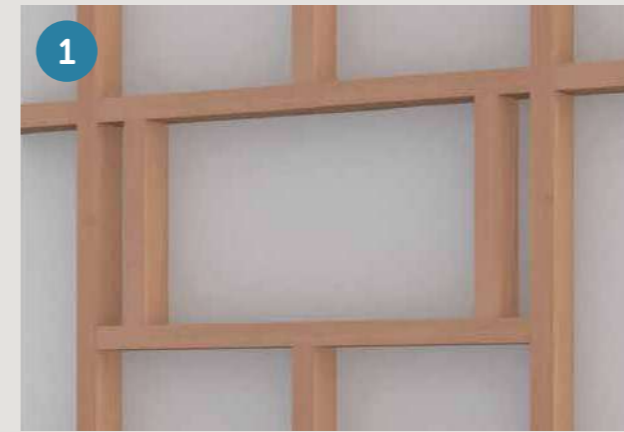

1 Rough-In timber framing to support niche - Ref (Niche Rough-In Guide)



2 Fix Gib / Villa Board, dry fit niche, remove and apply adhesive.

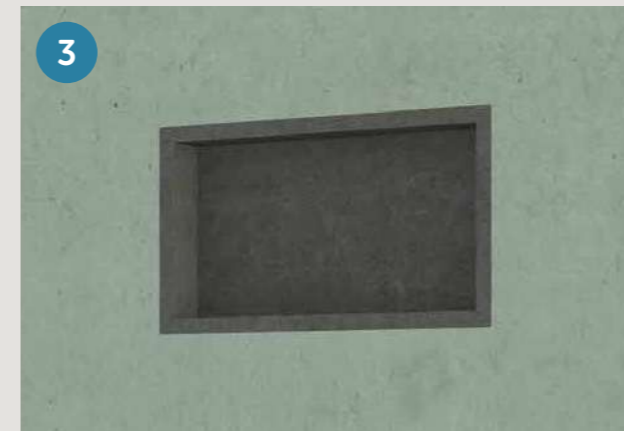

3 Install niche, ensuring front face is flush with front face of Gib/Villa Board.

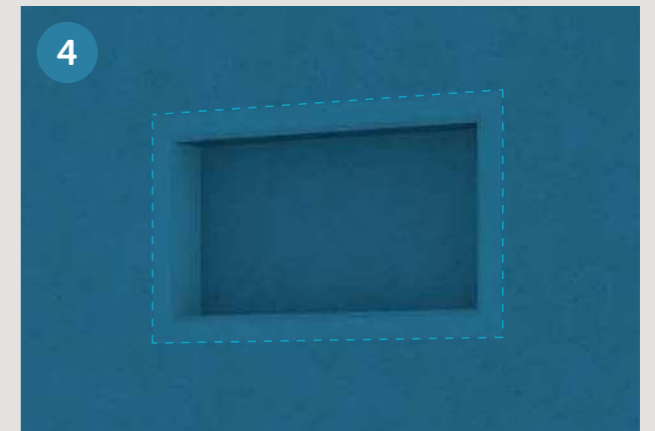

4 Apply Butyl Tapes and waterproof wall and niche.



5 Tile niche, grout and silicone all corner joints

## RECESSED NICHE 95MM STUD

Type	Model	Timber Rough-In			Actual Niche Size (excludes tiles)	
		Width	Height	Depth	A	B
Foot Rest		300	250	95	295	245
Square	300 X 300	400	400	95	395	395
Rectangle	600 X 300	700	400	95	695	395
Rectangle	800 X 300	900	400	95	895	395
Rectangle	900 X 300	1000	400	95	995	395
Rectangle	1000 X 300	1100	400	95	1095	395
Rectangle	1200 X 300	1300	400	95	1295	395
Rectangle	1500 X 300	1600	400	95	1595	395

\*Also available in 75mm stud depth on request

## SHOWER MIXER POSITION?

With today's Walk-In showers becoming larger and more popular than ever it is important that the mixer position be considered so the bather can adjust temperature during showering.

After the first minute of showering the body's skin receptors become acclimatised to the original temperature set and requires an incremental increase of 1°C every minute over a two-minute period to eliminate any body cooling effect.

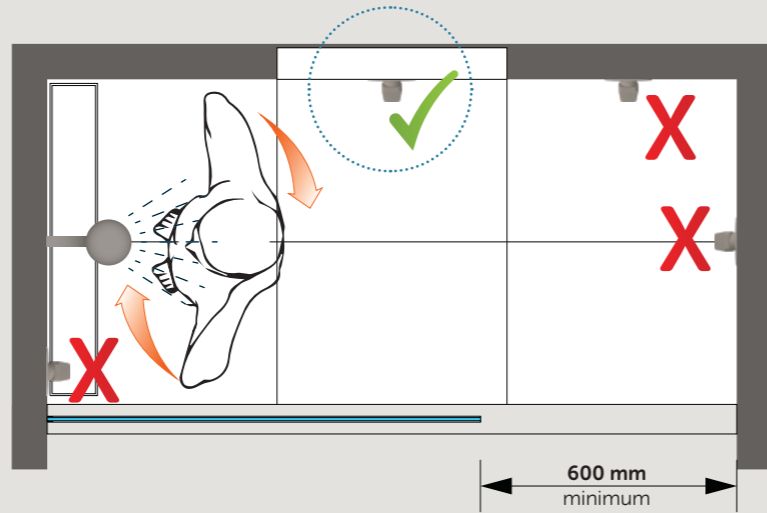

The shower mixer be should be positioned where the bather can easily reach the mixer to adjust water temperature during showering.

## SHOWER MIXER & NICHE HEIGHT?

If specifying a recessed shower niche, then you will need to ensure your plumber installs the shower mixer to the recommended height of 1000 mm off the sub floor allowing sufficient clearance between mixer elbow and niche nog support.

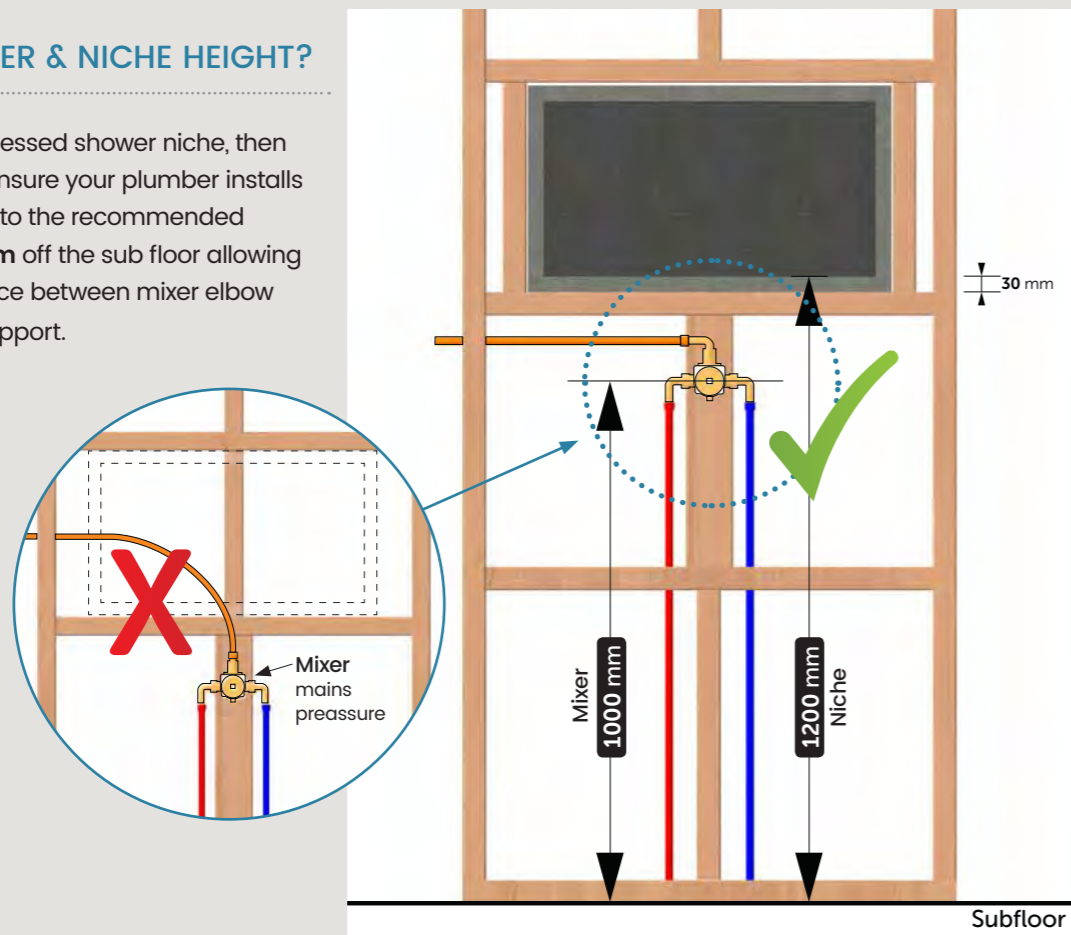

## SHOWER NICHE HEIGHT CALCULATION - Elusion Threshold Base only

Oben recommends internal niche shelf height is set at 1200 mm off sub floor. This allows for a 20 mm safety buffer which can be used to raise the niche shelf tile height junction to match the finished wall tile height.

Ask your builder to consult with your tiler regarding your actual shower recess height required as this may vary depending on actual tile size selection, grout joints and tiled floor levels.

Tiles are a nominal size and can vary from actual size advertised. Example 600 X 600 tile may be only 595 X 595.

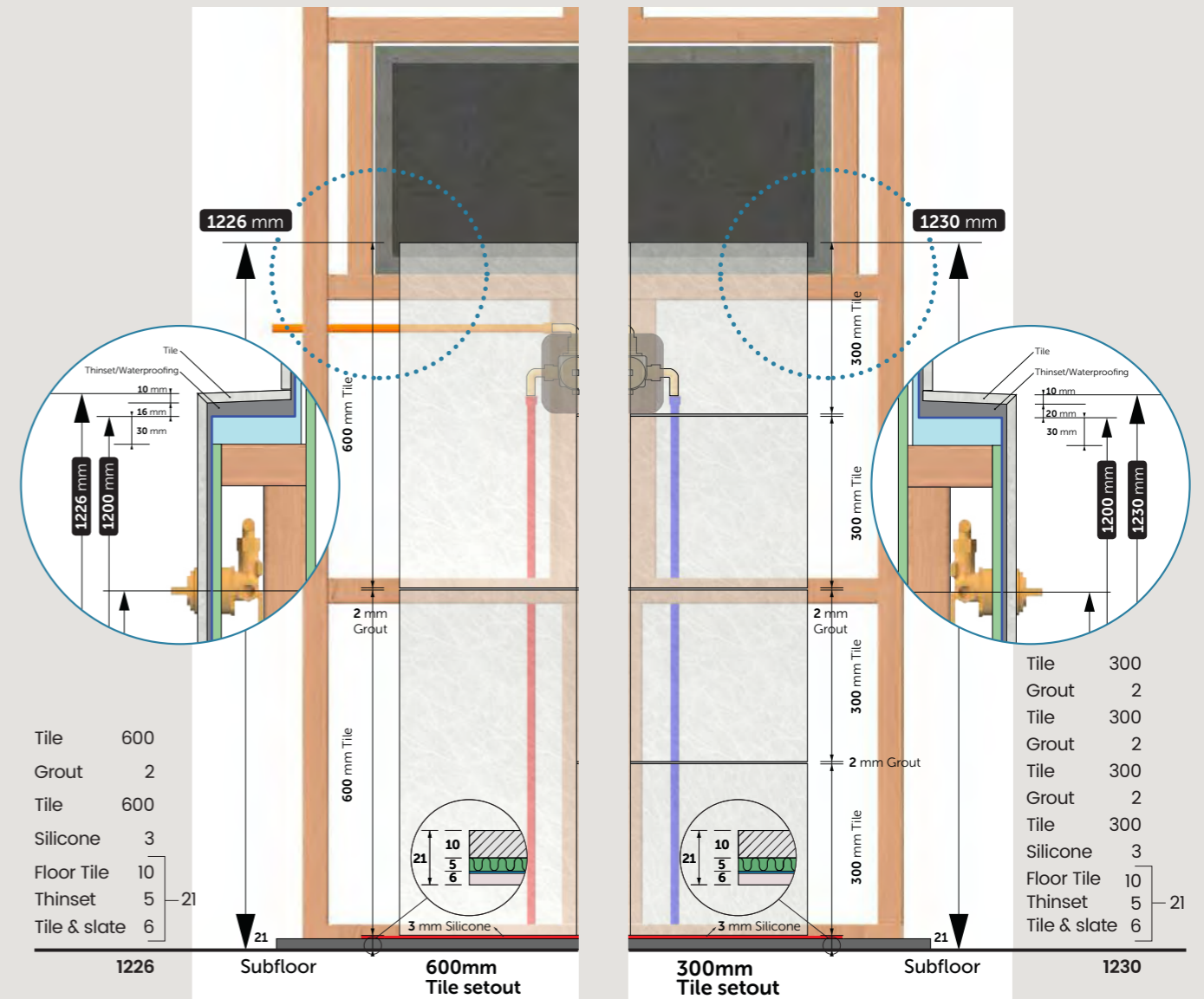

**\*IMPORTANT.** Above niche height recommendations are not suitable for Elusion Level Entry Bases as rebate depth varies between models effecting tile datum. Please refer to Oben website (Elusion Level Entry Rough-In Guide PDF)

**IMPORTANT.** Tile layout dimensions and drawings provided are to be used as a "GUIDE ONLY" and actual niche height must be specified by a tiler in conjunction with your builder in order to determine the niche height required to suit your wall tile selection.

## More Oben brochures

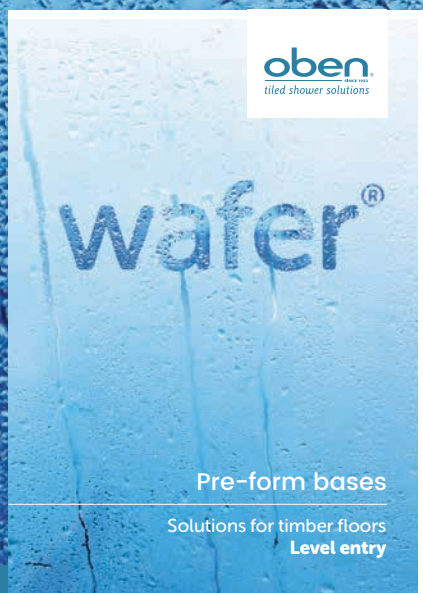

Oben  
10.B Parity Place  
Hillcrest  
Auckland 0627  
T: 09 44 33 879  
E: sales@oben.co.nz  
www.oben.co.nz

Oben reserves all rights to alter designs and specifications without notice. All dimensions given are approximate and should be checked prior to installation. Products shown in Catalogues, Order Forms and digital format are subject to Intellectual Property Protection. NZ and International Patents Pending, ® Registered Trademarks of Oben. Oben's continuous product improvement policy means some product enhancements may not be available at time of order placement due to current stock and phasing in/out of new models.

Quotations valid 30 days from date of quote. Prices subject to re quote after expiry of 30 days. Prices quoted are subject to final site measure. (Contact Oben Customer Service for further details.) Tapware & Accessories featured in photography are not included.

**oben**  
SINCE 1923  
tiled shower solutions

•Design •Quality •Service

All products available Ex Oben warehouse Auckland and do not include shipping & handling costs which will be charged separately on invoices. Custom made to order products are Non-Refundable.

© Oben Elusion® Brochure April 2019